

# ViewSonic®



---

## **PJD5151/PJD5153/PJD5155/ PJD5250/PJD5253/PJD5255/ PJD5555w\_Tiger DLP Projector User Guide**

---

**IMPORTANT:** Please read this User Guide to obtain important information on installing and using your product in a safe manner, as well as registering your product for future service. Warranty information contained in this User Guide will describe your limited coverage from ViewSonic Corporation, which is also found on our web site at <http://www.viewsonic.com> in English, or in specific languages using the Regional selection box in the upper right corner of our website. "Antes de operar su equipo lea cuidadosamente las instrucciones en este manual"

---

**Model No.**  
VS15871/VS15872/VS15873/  
VS15874/VS14115/VS15875/  
VS15876

## Thank you for choosing ViewSonic

With over 25 years as a world leading provider of visual solutions, ViewSonic is dedicated to exceeding the world's expectations for technological evolution, innovation, and simplicity. At ViewSonic, we believe that our products have the potential to make a positive impact in the world, and we are confident that the ViewSonic product you have chosen will serve you well.

Once again, thank you for choosing ViewSonic !



# Compliance Information

## FCC Compliance Statement

This device complies with part 15 of FCC Rules. Operation is subject to the following two conditions: (1) this device may not cause harmful interference, and (2) this device must accept any interference received, including interference that may cause undesired operation.

This equipment has been tested and found to comply with the limits for a Class B digital device, pursuant to part 15 of the FCC Rules. These limits are designed to provide reasonable protection against harmful interference in a residential installation. This equipment generates, uses, and can radiate radio frequency energy, and if not installed and used in accordance with the instructions, may cause harmful interference to radio communications. However, there is no guarantee that interference will not occur in a particular installation. If this equipment does cause harmful interference to radio or television reception, which can be determined by turning the equipment off and on, the user is encouraged to try to correct the interference by one or more of the following measures:

- Reorient or relocate the receiving antenna.
- Increase the separation between the equipment and receiver.
- Connect the equipment into an outlet on a circuit different from that to which the receiver is connected.
- Consult the dealer or an experienced radio/TV technician for help.

**Warning:** You are cautioned that changes or modifications not expressly approved by the party responsible for compliance could void your authority to operate the equipment.

## Industry Canada Statement

CAN ICES-3 (B)/NMB-3(B)

## CE Conformity for European Countries

 The device complies with the EMC Directive 2004/108/EC and Low Voltage Directive 2006/95/EC.

### Following information is only for EU-member states:

The mark is in compliance with the Waste Electrical and Electronic Equipment Directive 2012/19/EU (WEEE).

The mark indicates the requirement NOT to dispose the equipment including any spent or discarded batteries or accumulators as unsorted municipal waste, but use the return and collection systems available.

If the batteries, accumulators and button cells included with this equipment, display the chemical symbol Hg, Cd, or Pb, then it means that the battery has a heavy metal content of more than 0.0005% Mercury or more than, 0.002% Cadmium, or more than 0.004% Lead.



## Declaration of RoHS2 Compliance

This product has been designed and manufactured in compliance with Directive 2011/65/EU of the European Parliament and the Council on restriction of the use of certain hazardous substances in electrical and electronic equipment (RoHS2 Directive) and is deemed to comply with the maximum concentration values issued by the European Technical Adaptation Committee (TAC) as shown below:

Substance	Proposed Maximum Concentration	Actual Concentration
Lead (Pb)	0.1%	< 0.1%
Mercury (Hg)	0.1%	< 0.1%
Cadmium (Cd)	0.01%	< 0.01%
Hexavalent Chromium (Cr <sup>6+</sup> )	0.1%	< 0.1%
Polybrominated biphenyls (PBB)	0.1%	< 0.1%
Polybrominated diphenyl ethers (PBDE)	0.1%	< 0.1%

Certain components of products as stated above are exempted under the Annex III of the RoHS2 Directives as noted below:

Examples of exempted components are:

1. Mercury in cold cathode fluorescent lamps and external electrode fluorescent lamps (CCFL and EEFL) for special purposes not exceeding (per lamp):
  - (1) Short length ( $\leq 500$  mm): maximum 3.5 mg per lamp.
  - (2) Medium length ( $> 500$  mm and  $\leq 1,500$  mm): maximum 5 mg per lamp.
  - (3) Long length ( $> 1,500$  mm): maximum 13 mg per lamp.
2. Lead in glass of cathode ray tubes.
3. Lead in glass of fluorescent tubes not exceeding 0.2% by weight.
4. Lead as an alloying element in aluminium containing up to 0.4% lead by weight.
5. Copper alloy containing up to 4% lead by weight.
6. Lead in high melting temperature type solders (i.e. lead-based alloys containing 85% by weight or more lead).
7. Electrical and electronic components containing lead in a glass or ceramic other than dielectric ceramic in capacitors, e.g. piezoelectric devices, or in a glass or ceramic matrix compound.

## Indian Restriction of Hazardous Substances

Restriction on Hazardous Substances statement (India) This product complies with the "India E-waste Rule 2011" and prohibits use of lead, mercury, hexavalent chromium, polybrominated biphenyls or polybrominated diphenyl ethers in concentrations exceeding 0.1 weight % and 0.01 weight % for cadmium, except for the exemptions set in Schedule 2 of the Rule.

## Important Safety Instructions

1. Read these instructions.
2. Keep these instructions.
3. Heed all warnings.
4. Follow all instructions.
5. Do not use this unit near water.
6. Clean with a soft, dry cloth.
7. Do not block any ventilation openings. Install the unit in accordance with the manufacturer's instructions.
8. Do not install near any heat sources such as radiators, heat registers, stoves, or other devices (including amplifiers) that produce heat.
9. Do not defeat the safety purpose of the polarized or grounding-type plug. A polarized plug has two blades with one wider than the other. A grounding type plug has two blades and a third grounding prong. The wide blade and the third prong are provided for your safety. If the provided plug does not fit into your outlet, consult an electrician for replacement of the obsolete outlet.
10. Protect the power cord from being walked on or pinched particularly at plugs. Convenience receptacles and the point where they exit from the unit. Be sure that the power outlet is located near the unit so that it is easily accessible.
11. Only use attachments/accessories specified by the manufacturer.
12. Use only with the cart, stand, tripod, bracket, or table specified by the manufacturer, or sold with the unit. When a cart is used, use caution when moving the cart/unit combination to avoid injury from tipping over.
13. Unplug this unit when unused for long periods of time.
14. Refer all servicing to qualified service personnel. Servicing is required when the unit has been damaged in any way, such as: if the power-supply cord or plug is damaged, if liquid is spilled onto or objects fall into the unit, if the unit is exposed to rain or moisture, or if the unit does not operate normally or has been dropped.



# Copyright Information

Copyright © ViewSonic Corporation, 2015. All rights reserved.

Macintosh and Power Macintosh are registered trademarks of Apple Inc.

Microsoft, Windows, and the Windows logo are registered trademarks of Microsoft Corporation in the United States and other countries.

ViewSonic and the three birds logo are registered trademarks of ViewSonic Corporation.

VESA is a registered trademark of the Video Electronics Standards Association.

DPMS and DDC are trademarks of VESA.

PS/2, VGA and XGA are registered trademarks of International Business Machines Corporation.

Disclaimer: ViewSonic Corporation shall not be liable for technical or editorial errors or omissions contained herein; nor for incidental or consequential damages resulting from furnishing this material, or the performance or use of this product.

In the interest of continuing product improvement, ViewSonic Corporation reserves the right to change product specifications without notice. Information in this document may change without notice.

No part of this document may be copied, reproduced, or transmitted by any means, for any purpose without prior written permission from ViewSonic Corporation.

## Product Registration

To fulfill possible future product needs, and to receive additional product information as it becomes available, please visit your region section on ViewSonic's website to register your product online.

The ViewSonic CD also provides an opportunity for you to print the product registration form. Upon completion, please mail or fax to a respective ViewSonic office. To find your registration form, use the directory “:\CD\Registration”.

Registering your product will best prepare you for future customer service needs. Please print this user guide and fill the information in the “For Your Records” section. For additional information, please see the “Customer Support” section in this guide.

### For Your Records

<b>Product Name:</b>	PJD5151/PJD5153/PJD5155/PJD5250/PJD5253/ PJD5255/PJD5555w ViewSonic DLP Projector
<b>Model Number:</b>	VS15871/VS15872/VS15873/VS15874/VS14115/ VS15875/VS15876
<b>Document Number:</b>	PJD5151/PJD5153/PJD5155/PJD5250/PJD5253/ PJD5255/PJD5555w_UG_ENG Rev. 1B 12-18-14
<b>Serial Number:</b>	_____
<b>Purchase Date:</b>	_____

#### Product disposal at end of product life

The lamp in this product contains mercury which can be dangerous to you and the environment. Please use care and dispose of in accordance with local, state or federal laws.

ViewSonic respects the environment and is committed to working and living green.

Thank you for being part of Smarter, Greener Computing.

Please visit ViewSonic website to learn more.

USA & Canada: <http://www.viewsonic.com/company/green/recycle-program/>

Europe: <http://www.viewsoniceurope.com/uk/support/recycling-information/>

Taiwan: <http://recycle.epa.gov.tw/recycle/index2.aspx>

# *Table of contents*

---

## **Important safety instructions .....2**

## **Introduction.....4**

Projector features .....	4
Shipping contents.....	5
Projector exterior view.....	6
Controls and functions .....	7

## **Positioning your projector.....12**

Choosing a location.....	12
Projection dimensions .....	13

## **Connection .....15**

Connecting a computer or monitor ....	16
Connecting Video source devices .....	17
Using the cable management cover (optional accessory) .....	19

## **Operation .....20**

Starting up the projector.....	20
Using the menus.....	21
Utilizing the password function .....	22
Switching input signal.....	24
Adjusting the projected image .....	25
Magnifying and searching for details .....	26
Selecting the aspect ratio .....	27
Optimizing the image.....	28
Setting the presentation timer .....	31
Hiding the image.....	33
Locking control keys.....	33
Operating in a high altitude environment .....	33

Using the CEC function.....	34
Using the 3D functions .....	34
Using the projector in standby mode.	35
Adjusting the sound .....	35
Shutting down the projector .....	36
Menu operation.....	37

## **Maintenance .....46**

Care of the projector .....	46
Using the dust filter (optional accessory) .....	47
Lamp information .....	48

## **Troubleshooting .....52**

## **Specifications .....53**

Projector specifications.....	53
Dimensions .....	55
Ceiling mount installation .....	55
Timing chart .....	56

## **Copyright information...60**

## **Appendix .....61**

IR control table .....	61
RS232 command table.....	62



# Important safety instructions

---

Your projector is designed and tested to meet the latest standards for safety of information technology equipment. However, to ensure safe use of this product, it is important that you follow the instructions mentioned in this manual and marked on the product.

## Safety Instructions

1. **Please read this manual before you operate your projector.** Save it for future reference.
2. **Do not look straight at the projector lens during operation.** The intense light beam may damage your eyes.
3. **Refer servicing to qualified service personnel.**
4. **Always open the lens shutter or remove the lens cap when the projector lamp is on.**
5. In some countries, the line voltage is NOT stable. This projector is designed to operate safely within a mains voltage between 100 to 240 volts AC, but could fail if power cuts or surges of  $\pm 10$  volts occur. **In areas where the mains voltage may fluctuate or cut out, it is recommended that you connect your projector through a power stabilizer, surge protector or uninterruptible power supply (UPS).**
6. Do not block the projection lens with any objects when the projector is under operation as this could cause the objects to become heated and deformed or even cause a fire. To temporarily turn off the lamp, press BLANK on the projector or remote control.
7. The lamp becomes extremely hot during operation. Allow the projector to cool for approximately 45 minutes prior to removing the lamp assembly for replacement.
8. Do not operate lamps beyond the rated lamp life. Excessive operation of lamps beyond the rated life could cause them to break on rare occasions.
9. Never replace the lamp assembly or any electronic components unless the projector is unplugged.
10. Do not place this product on an unstable cart, stand, or table. The product may fall, sustaining serious damage.
11. Do not attempt to disassemble this projector. There are dangerous high voltages inside which may cause death if you should come into contact with live parts. The only user serviceable part is the lamp which has its own removable cover.  
Under no circumstances should you ever undo or remove any other covers. Refer servicing only to suitably qualified professional service personnel.
12. Do not place this projector in any of the following environments.
  - Space that is poorly ventilated or confined. Allow at least 50 cm clearance from walls and free flow of air around the projector.
  - Locations where temperatures may become excessively high, such as the inside of a car with all windows rolled up.
  - Locations where excessive humidity, dust, or cigarette smoke may contaminate optical components, shortening the projector's life span and darkening the picture.
  - Locations near fire alarms
  - Locations with an ambient temperature above 40°C / 104°F
  - Locations where the altitudes are higher than 3000 m (10000 feet).

13. Do not block the ventilation holes. If the ventilation holes are seriously obstructed, overheating inside the projector may result in a fire.
  - Do not place this projector on a blanket, bedding or any other soft surface.
  - Do not cover this projector with a cloth or any other item.
  - Do not place inflammables near the projector.
14. Always place the projector on a level, horizontal surface during operation.
  - Do not use if tilted at an angle of more than 10 degrees left to right, nor at angle of more than 15 degrees front to back. Using the projector when it is not fully horizontal may cause a malfunction of, or damage to, the lamp.
15. Do not stand the projector on end vertically. Doing so may cause the projector to fall over, causing injury or resulting in damage to the projector.
16. Do not step on the projector or place any objects upon it. Besides probable physical damage to the projector, doing so may result in accidents and possible injury.
17. Do not place liquids near or on the projector. Liquids spilled into the projector may cause it to fail. If the projector does become wet, disconnect it from the power supply's wall socket and call your local service center to have the projector serviced.
18. This product is capable of displaying inverted pictures for ceiling mount installation.  
 **Use only qualified ceiling mount kit for mounting the projector and ensure it is securely installed.**
19. When the projector is under operation, you may sense some heated air and odor from its ventilation grill. It is a normal phenomenon and not a product defect.
20. Do not use the Security bar for transporting or installation. It should be used with a commercially available theft prevention cable.

## Safety instructions for ceiling mounting of the projector

We want you to have a pleasant experience using your projector, so we need to bring this safety matter to your attention to prevent damage to person and property.

If you intend to mount your projector on the ceiling, we strongly recommend that you use a proper fitting projector ceiling mount kit and that you ensure it is securely and safely installed.

If you use an inappropriate projector ceiling mount kit, there is a safety risk that the projector may fall from the ceiling due to an improper attachment through the use of the wrong gauge or length screws.

You can purchase a projector ceiling mount kit from the place you purchased your projector. We recommend that you also purchase a separate security cable and attach it securely to both the anti-theft lock slot on the projector and the base of the ceiling mount bracket. This will perform the secondary role of restraining the projector should its attachment to the mounting bracket become loose.

# Introduction

---

## Projector features

The projector integrates high-performance optical engine projection and a user-friendly design to deliver high reliability and ease of use.

The projector offers the following features.

- Dynamic mode adjusting the power consumption of the lamp according to the brightness of the image being projected
- Power saving function decreasing the power consumption of the lamp by up to 70% when no input signal can be detected for a set period of time.
- Presentation timer for better control of time during presentations
- Supports 3D display
- Supports Blu-ray 3D display (for models with HDMI input)
- Color Management allowing color adjustments to your liking
- Less than 0.5W power consumption when power saving mode is turned on
- Screen Color correction allowing projection on surfaces of several predefined colors
- Quick auto search speeding up the signal detecting process
- Color modes providing choices for different projection purposes
- Selectable quick power off function
- One-key auto-adjustment to display the best picture quality
- Digital keystone correction to correct distorted images
- Adjustable color management control for data/video display
- Ability to display 1.07 billion colors
- Multi-language On-Screen Display (OSD) menus
- Switchable normal and economic modes to reduce the power consumption
- Component HDTV compatibility (YPbPr)
- HDMI CEC (Consumer Electronics Control) function allows synchronized power ON/OFF operation between the projector and a CEC-compatible DVD player device connected to the HDMI input of the projector

 **The apparent brightness of the projected image will vary depending on the ambient lighting conditions, selected input signal contrast/brightness settings, and is directly proportional to projection distance.**

 **The lamp brightness will decline over time and may vary within the lamp manufacturers specifications. This is normal and expected behavior.**

# Shipping contents

Carefully unpack and verify that you have all of the items shown below. If any of these items are missing, please contact your place of purchase.

## Standard accessories

 The supplied accessories will be suitable for your region, and may differ from those illustrated.

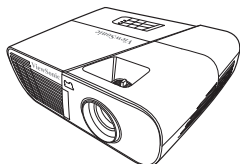

Projector

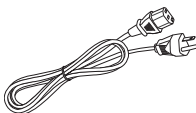

Power Cord

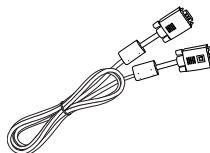

VGA Cable



Multi-language User  
Manual CD



Quick Start Guide

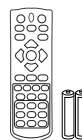

Remote Control & Batteries

## Optional accessories

1. Replacement lamp (RLC-092 for PJD5151/PJD5153/PJD5155/PJD5250/PJD5253/PJD5255. RLC-093 for PJD5555w)
2. Soft carry case
3. VGA-Component adapter
4. Dust filter
5. Cable management cover

# Projector exterior view

## Front/upper side

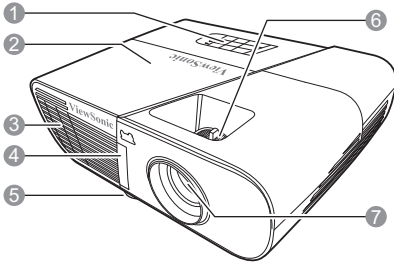

## Rear/lower side

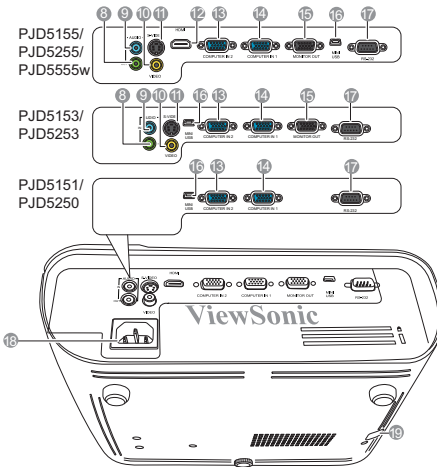

1. External control panel  
(See "Projector" on page 7 for details.)
2. Lamp cover
3. Vent (heated air exhaust)
4. Front IR remote sensor
5. Adjuster foot
6. Focus and Zoom rings
7. Projection lens
8. Audio signal output socket
9. Audio signal input socket
10. Video input socket
11. S-Video input socket
12. HDMI port
13. RGB (PC)/Component video (YPbPr/YCbCr) signal input socket-2
14. RGB (PC)/Component video (YPbPr/YCbCr) signal input socket-1
15. RGB signal output socket
16. Mini USB port
17. RS-232 control port
18. AC power cord inlet
19. Security bar for anti-theft lock slot

### ⚠ Warning

- **THIS APPARATUS MUST BE EARTHED.**
- **When installing the unit, incorporate a readily accessible disconnect device in the fixed wiring, or connect the power plug to an easily accessible socket-outlet near the unit. If a fault should occur during operation of the unit, operate the disconnect device to switch the power supply off, or disconnect the power plug.**

# Controls and functions

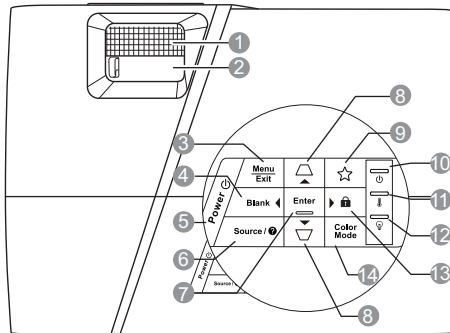

## Projector





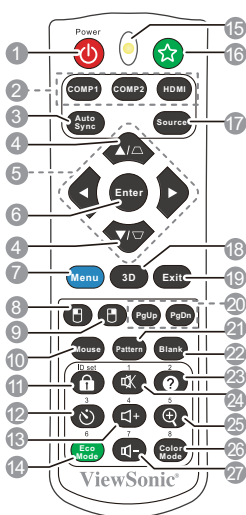



- 1. Focus ring**  
Adjusts the focus of the projected image.
- 2. Zoom ring**  
Adjusts the size of the projected image.
- 3. Menu**  
Turns on the On-Screen Display (OSD) menu.  
**Exit**  
Goes back to previous OSD menu, exits and saves menu settings.
- 4. Blank/◀ Left**  
Hides the screen picture.
- 5. ⏻ Power**  
Toggles the projector between standby mode and Power ON.
- 6. Source**  
Displays the source selection bar.  
**⌂ (Help)**  
Displays the HELP menu by a long press for 3 seconds.
- 7. Enter**  
Enacts the selected On-Screen Display (OSD) menu item.
- 8. ▢ / ▣ (Keystone keys)**  
Manually corrects distorted images resulting from an angled projection.  
**▲ Up/ ▼ Down (Arrow keys)**
- 9. ☆ (My Button)**  
Allows user to define a short cut key on this button, and the function item is selected in OSD menu.
- 10. ⏻ (Power indicator light)**  
Lights up or flashes when the projector is under operation.
- 11. 🌡️ (Temperature indicator light)**  
Lights up red if the projector's temperature becomes too high.
- 12. 💡 (Lamp indicator light)**  
Indicates the status of the lamp. Lights up or flashes when the lamp has developed a problem.
- 13. 🔒 (Panel Key Lock)**  
Activates or disables panel key lock by a long press for 3 seconds.  
**▶ Right**  
When the On-Screen Display (OSD) menu is activated, the #4, #8 and #13 keys are used as directional arrows to select the desired menu items and to make adjustments.
- 14. Color Mode**  
Selects an available picture setup mode.

# Remote control





 To use the remote mouse control keys (Page Up, Page Down, , and ) see "Using the remote mouse control" on page 10 for details.

1.  **Power**  
Toggles the projector between standby mode and Power ON.
2. **Source selection keys**
  - **COMP1/COMP2**  
Selects **D-Sub / Comp. 1** or **D-Sub / Comp. 2** source for display.
  - **HDMI**  
Selects **HDMI** source for display.
3. **Auto Sync**  
Automatically determines the best picture timings for the displayed image.
4.  **(Keystone keys)**  
Manually corrects distorted images resulting from an angled projection.
5.  **Left/ Right/ Up/ Down**  
Selects the desired menu items and makes adjustments.

6. **Enter**  
Enacts the selected On-Screen Display (OSD) menu item.
7. **Menu**  
Turns on the On-Screen Display (OSD) menu.
8.  **(Left mouse button)**  
Performs the same function as the left mouse button when the mouse mode is activated.  
 **Only available when a PC input signal is selected.**
9.  **(Right mouse button)**  
Performs the same function as the right mouse button when the mouse mode is activated.  
 **Only available when a PC input signal is selected.**

## 10. Mouse

Switches between the normal and mouse modes.

**PgUp, PgDn,  **: active after pressing **Mouse**. An icon appears on the screen to indicate the activation of the mouse mode.



**Only available when a PC input signal is selected.**

## 11. (Panel Key Lock)

Activates panel key lock.

## 12. (Presentation Timer)

Displays the presentation timer settings menu.

## 13. + (Volume Up)

Increases the volume level.

## 14. Eco Mode

Selects a lamp mode.

## 15. LED indicator

## 16. ☆ (My Button)

Allows user to define a short cut key on the remote control, and the function item is selected in OSD menu.

## 17. Source

Displays the source selection bar.

## 18. 3D

Displays the 3D settings menu.

## 19. Exit

Goes back to previous OSD menu, exits and saves menu settings.

## 20. PgUp (Page Up)/PgDn (Page Down)

Operates your display software program (on a connected PC) which responds to page up/down commands (like Microsoft PowerPoint) when the mouse mode is activated.



**Only available when a PC input signal is selected.**

## 21. Pattern

Displays embedded test pattern.

## 22. Blank

Hides the screen picture.

## 23. (Help)

Displays the HELP menu.

## 24. (Mute)

Toggles the projector audio between on and off.

## 25. (Zoom)

Displays the zoom bar that magnifies or reduces the projected picture size.

## 26. Color Mode

Selects an available picture setup mode.

## 27. - (Volume Down)

Decreases the volume level.

## Remote control code

The projector can be assigned to 8 different remote control codes, 1 to 8. When several adjacent projectors are in operation at the same time, switching the remote control codes can prevent interference from other remote controls. Set the remote control code for the projector first before changing that for the remote control.

To switch the code for the projector, select from among 1 to 8 in the **SYSTEM SETTING: ADVANCED > Remote Control Code** menu.

To switch the code for the remote control, press **ID set** and the number button corresponding to the remote control code set in the projector OSD together for 5 seconds or more. The initial code is set to 1. When the code is switched to 8, the remote control can control every projector.



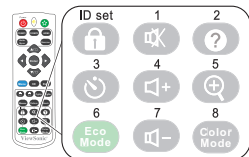

**If different codes are set on the projector and remote control, there will be no response from the remote control. When that happens, switch the code for the remote control again.**





## Using the remote mouse control

The capability of operating your computer with the remote control gives you more flexibility when delivering presentations.

1. Connect the projector to your PC or notebook with a USB cable prior to using the remote control in place of your computer's mouse. See ["Connecting a computer" on page 16](#) for details.
2. Set the input signal to **D-Sub / Comp. 1** or **D-Sub / Comp. 2**.
3. Press **Mouse** on the remote control to switch from the normal mode to the mouse mode. An icon appears on the screen to indicate the activation of the mouse mode.
4. Perform the desired mouse controls on your remote control.
  - To move the cursor on the screen, press ◀/▲/▼/▶.
  - To left-click, press .
  - To right-click, press .
  - To operate your display software program (on a connected PC) which responds to page up/down commands (like Microsoft PowerPoint), press **PgUp/PgDn**.
  - To return to the normal mode, press **Mouse** again or other keys except for the mouse related multi-function keys.

## Remote control effective range

The Infra-Red (IR) remote control is located on the front of the projector. The remote control must be held at an angle within 30 degrees perpendicular to the projector's IR remote control sensor to function correctly. The distance between the remote control and the sensor should not exceed 8 meters (~ 26 feet).

Make sure that there are no obstacles between the remote control and the IR sensor on the projector that might obstruct the infra-red beam.

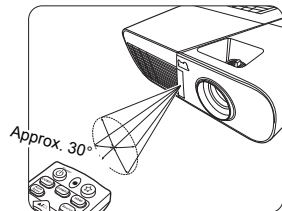

## Replacing the remote control batteries

1. To open the battery cover, turn the remote control over to view its back, press on the finger grip on the cover and pull it up in the direction of the arrow as illustrated.
2. Remove any existing batteries (if necessary) and install two AAA batteries observing the battery polarities as indicated in the base of the battery compartment. Positive (+) goes to positive and negative (-) goes to negative.
3. Refit the cover by aligning it with the base and pushing it back down into position. Stop when it clicks into place.

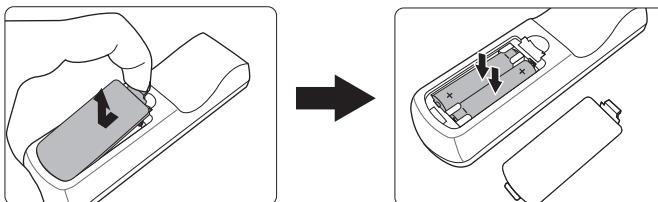

### WARNING

- **Avoid leaving the remote control and batteries in an excessive heat or humid environment like the kitchen, bathroom, sauna, sunroom or in a closed car.**
- **Replace only with the same or equivalent type recommended by the battery manufacturer.**
- **Dispose of the used batteries according to the manufacturer's instructions and local environment regulations for your region.**
- **Never throw the batteries into a fire. There may be danger of an explosion.**
- **If the batteries are drained or if you will not be using the remote control for an extended period of time, remove the batteries to avoid damage to the remote control from possible battery leakage.**

# Positioning your projector

---

## Choosing a location

Your room layout or personal preference will dictate which installation location you select. Take into consideration the size and position of your screen, the location of a suitable power outlet, as well as the location and distance between the projector and the rest of your equipment.

Your projector is designed to be installed in one of the following 4 possible installation locations:

### 1. Front Table

Select this location with the projector placed near the floor in front of the screen. This is the most common way to position the projector for quick setup and portability.

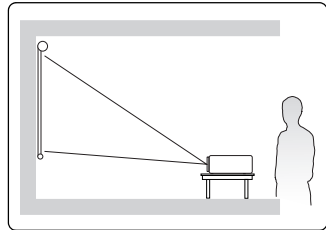

### 2. Front Ceiling

Select this location with the projector suspended upside-down from the ceiling in front of the screen.

Purchase the projector ceiling mount kit from your dealer to mount your projector on the ceiling.

Set **Front Ceiling** in the **SYSTEM SETTING: BASIC > Projector Position** menu after you turn the projector on.

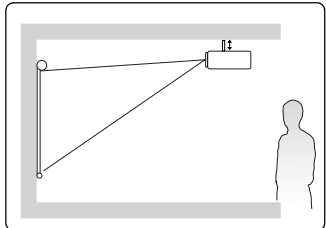

### 3. Rear Ceiling

Select this location with the projector suspended upside-down from the ceiling behind the screen.

Note that a special rear projection screen and the projector ceiling mounting kit are required for this installation location.

Set **Rear Ceiling** in the **SYSTEM SETTING: BASIC > Projector Position** menu after you turn the projector on.

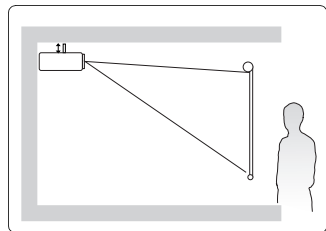

### 4. Rear Table

Select this location with the projector placed near the floor behind the screen.

Note that a special rear projection screen is required.

Set **Rear Table** in the **SYSTEM SETTING: BASIC > Projector Position** menu after you turn the projector on.

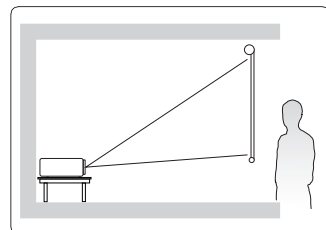

# Projection dimensions

 The "screen" mentioned below refers to the projection screen usually consisting of a screen surface and a support structure.

## PJD5151/PJD5153/PJD5155/PJD5250/PJD5253/ PJD5255

- 4:3 image on a 4:3 screen

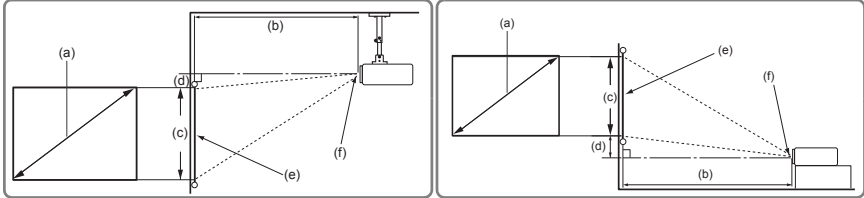

- 16:9 image on a 4:3 screen

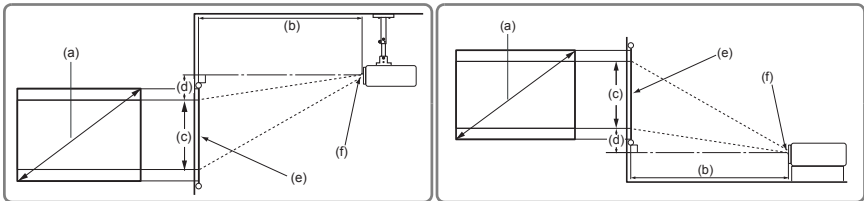

(e): Screen

(f): Center of lens

(a) Screen Size [inch (m)]	4:3 image on a 4:3 Screen				16:9 image on a 4:3 Screen			
	(b) Projection distance [m (inch)]		(c) Image height [cm (inch)]	(d) Vertical offset [cm (inch)]	(b) Projection distance [m (inch)]		(c) Image height [cm (inch)]	(d) Vertical offset [cm (inch)]
	min.	max.			min.	max.		
30 (0.8)	1.1 (45)	1.2 (49)	46 (18)	4.6 (1.8)	1.1 (45)	1.2 (49)	34 (14)	10.3 (4.1)
40 (1.0)	1.5 (59)	1.7 (65)	61 (24)	6.1 (2.4)	1.5 (59)	1.7 (65)	46 (18)	13.7 (5.4)
50 (1.3)	1.9 (74)	2.1 (82)	76 (30)	7.6 (3.0)	1.9 (74)	2.1 (82)	57 (23)	17.1 (6.8)
60 (1.5)	2.3 (89)	2.5 (98)	91 (36)	9.1 (3.6)	2.3 (89)	2.5 (98)	69 (27)	20.6 (8.1)
70 (1.8)	2.6 (104)	2.9 (114)	107 (42)	10.7 (4.2)	2.6 (104)	2.9 (114)	80 (32)	24.0 (9.5)
80 (2.0)	3.0 (119)	3.3 (131)	122 (48)	12.2 (4.8)	3.0 (119)	3.3 (131)	91 (36)	27.4 (10.8)
90 (2.3)	3.4 (134)	3.7 (147)	137 (54)	13.7 (5.4)	3.4 (134)	3.7 (147)	103 (41)	30.9 (12.2)
100 (2.5)	3.8 (149)	4.2 (163)	152 (60)	15.2 (6.0)	3.8 (149)	4.2 (163)	114 (45)	34.3 (13.5)
120 (3.0)	4.5 (178)	5.0 (196)	183 (72)	18.3 (7.2)	4.5 (178)	5.0 (196)	137 (54)	41.1 (16.2)
150 (3.8)	5.7 (223)	6.2 (245)	229 (90)	22.9 (9.0)	5.7 (223)	6.2 (245)	171 (68)	51.4 (20.3)
200 (5.1)	7.5 (297)	8.3 (327)	305 (120)	30.5 (12.0)	7.5 (297)	8.3 (327)	229 (90)	68.6 (27.0)
250 (6.4)	9.4 (371)	10.4 (409)	381 (150)	38.1 (15.0)	9.4 (371)	10.4 (409)	286 (113)	85.7 (33.8)
300 (7.6)	11.3 (446)	12.5 (490)	457 (180)	45.7 (18.0)	11.3 (446)	12.5 (490)	343 (135)	102.9 (40.5)

# PJD5555w

- 16:10 image on a 16:10 screen

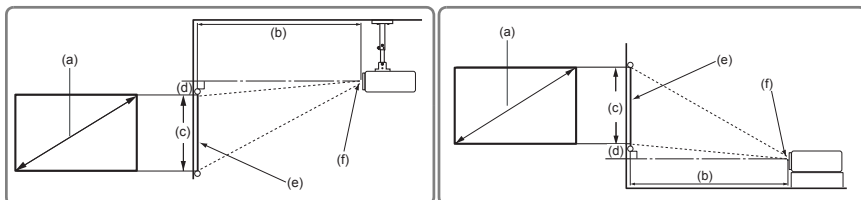

- 16:10 image on a 4:3 screen

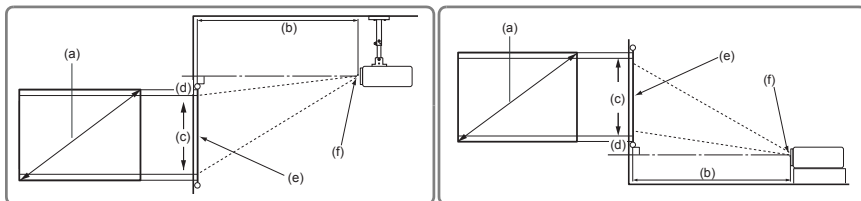

(e): Screen (f): Center of lens

(a) Screen Size [inch (m)]	16:10 image on a 16:10 Screen				16:10 image on a 4:3 Screen			
	(b) Projection distance [m (inch)]		(c) Image height [cm (inch)]	(d) Vertical offset [cm (inch)]	(b) Projection distance [m (inch)]		(c) Image height [cm (inch)]	(d) Vertical offset [cm (inch)]
	min.	max.			min.	max.		
30 (0.8)	1.0 (38)	1.1 (42)	40 (16)	0.0 (0.0)	0.9 (36)	1.0 (40)	38 (15)	0.0 (0.0)
40 (1.0)	1.3 (51)	1.4 (56)	54 (21)	0.0 (0.0)	1.2 (48)	1.3 (53)	51 (20)	0.0 (0.0)
50 (1.3)	1.6 (64)	1.8 (70)	67 (26)	0.0 (0.0)	1.5 (60)	1.7 (66)	64 (25)	0.0 (0.0)
60 (1.5)	1.9 (76)	2.1 (84)	81 (32)	0.0 (0.0)	1.8 (72)	2.0 (79)	76 (30)	0.0 (0.0)
70 (1.8)	2.3 (89)	2.5 (98)	94 (37)	0.0 (0.0)	2.1 (84)	2.3 (92)	89 (35)	0.0 (0.0)
80 (2.0)	2.6 (102)	2.8 (112)	108 (42)	0.0 (0.0)	2.4 (96)	2.7 (105)	102 (40)	0.0 (0.0)
90 (2.3)	2.9 (114)	3.2 (126)	121 (48)	0.0 (0.0)	2.7 (108)	3.0 (119)	114 (45)	0.0 (0.0)
100 (2.5)	3.2 (127)	3.5 (140)	135 (53)	0.0 (0.0)	3.0 (120)	3.3 (132)	127 (50)	0.0 (0.0)
120 (3.0)	3.9 (152)	4.3 (168)	162 (64)	0.0 (0.0)	3.7 (144)	4.0 (158)	152 (60)	0.0 (0.0)
150 (3.8)	4.8 (191)	5.3 (210)	202 (79)	0.0 (0.0)	4.6 (180)	5.0 (198)	191 (75)	0.0 (0.0)
200 (5.1)	6.5 (254)	7.1 (279)	269 (106)	0.0 (0.0)	6.1 (240)	6.7 (264)	254 (100)	0.0 (0.0)
250 (6.4)	8.1 (318)	8.9 (349)	337 (132)	0.0 (0.0)	7.6 (300)	8.4 (329)	318 (125)	0.0 (0.0)
300 (7.6)	9.7 (381)	10.6 (419)	404 (159)	0.0 (0.0)	9.1 (359)	10.0 (395)	381 (150)	0.0 (0.0)

☞ There is 3% tolerance among these numbers due to optical component variations. It is recommended that if you intend to permanently install the projector, you should physically test the projection size and distance using the actual projector in situ before you permanently install it, so as to make allowance for this projector's optical characteristics. This will help you determine the exact mounting position so that it best suits your installation location.

# Connection

When connecting a signal source to the projector, be sure to:

1. Turn all equipment off before making any connections.
2. Use the correct signal cables for each source.
3. Ensure the cables are firmly inserted.

 In the connections shown below, some cables may not be included with the projector (see "Shipping contents" on page 5). They are commercially available from electronics stores.

 The connection illustrations below are for reference only. The rear connecting jacks available on the projector vary with each projector model.

 For detailed connection methods, see pages 16-18.

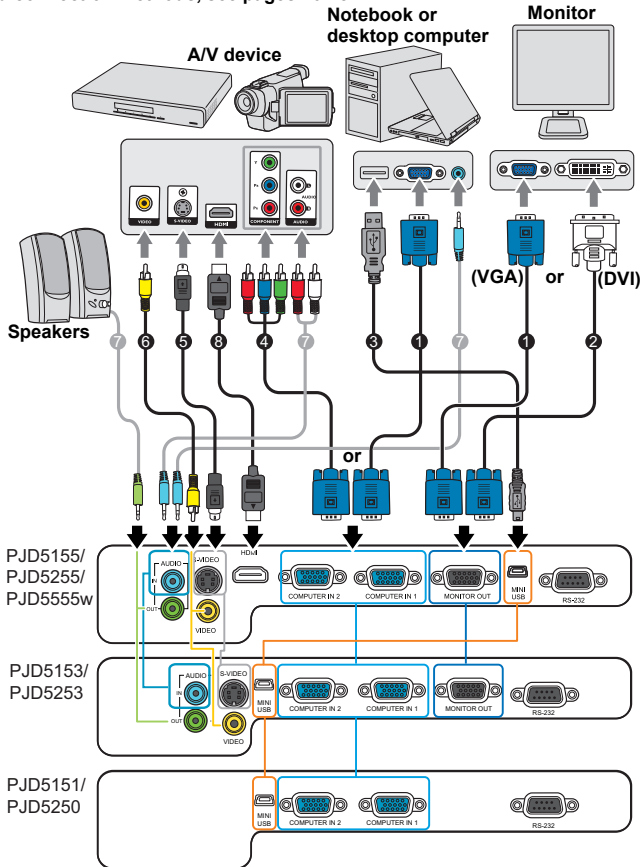

1. VGA cable	5. S-Video cable
2. VGA to DVI-A cable	6. Video cable
3. USB cable	7. Audio cable
4. Component Video to VGA (D-Sub) adapter cable	8. HDMI cable

# Connecting a computer or monitor

## Connecting a computer

1. Take the supplied VGA cable and connect one end to the D-Sub output socket of the computer.
2. Connect the other end of the VGA cable to the **COMPUTER IN 1** or **COMPUTER IN 2** signal input socket on the projector.
3. If you wish to use the remote mouse control function, take a USB cable and connect the larger end to the USB port of the computer, and smaller end to the **MINI USB** socket on the projector. See ["Using the remote mouse control" on page 10](#) for details.

 Many notebooks do not turn on their external video ports when connected to a projector. Usually a key combo like FN + F3 or CRT/LCD key turns the external display on/off. Locate a function key labeled CRT/LCD or a function key with a monitor symbol on the notebook. Press FN and the labeled function key simultaneously. Refer to your notebook's documentation to find your notebook's key combination.

## Connecting a monitor

If you want to view your presentation close-up on a monitor as well as on the screen, you can connect the **MONITOR OUT** signal output socket on the projector to an external monitor with a VGA cable following the instructions below:

1. Connect the projector to a computer as described in ["Connecting a computer" on page 16](#).
2. Take a suitable VGA cable (only one supplied) and connect one end of the cable to the D-Sub input socket of the video monitor.  
Or if your monitor is equipped with a DVI input socket, take a VGA to DVI-A cable and connect the DVI end of the cable to the DVI input socket of the video monitor.
3. Connect the other end of the cable to the **MONITOR OUT** socket on the projector.

 The **MONITOR OUT** output only works when **COMPUTER IN 1** connection is made to the projector.

 To use this connection method when the projector is in standby mode, turn on the **Active VGA Out** function under the **SOURCE > Standby Settings** menu.

# Connecting Video source devices

You can connect your projector to various Video source devices that provide any one of the following output sockets:

- HDMI
- Component Video
- S-Video
- Video (composite)

You need only connect the projector to a Video source device using just one of the above connecting methods, however each provides a different level of video quality. The method you choose will most likely depend upon the availability of matching terminals on both the projector and the Video source device as described below:

## Best video quality

The best available video connection method is HDMI. If your source device is equipped with an HDMI socket, you can enjoy uncompressed digital video quality.

See ["Connecting an HDMI device" on page 18](#) for how to connect the projector to an HDMI source device and other details.

If no **HDMI** source is available, the next best video signal is Component video (not to be confused with composite video). Digital TV tuner and DVD players output Component video natively, so if available on your devices, this should be your connection method of choice in preference to (composite) video.

See ["Connecting a Component Video source device" on page 18](#) for how to connect the projector to a component video device.

## Better video quality

The S-Video method provides a better quality analog video than standard composite Video. If you have both composite Video and S-Video output terminals on your Video source device, you should elect to use the S-Video option.

See ["Connecting an S-Video source device" on page 18](#) for how to connect the projector to an S-Video device.

## Least video quality

Composite Video is an analog video and will result in a perfectly acceptable, but less than optimal result from your projector, being the least video quality of the available methods described here.

See ["Connecting a composite Video source device" on page 19](#) for how to connect the projector to a composite Video device.

## Connecting audio

The projector has built-in mono speaker(s) which is designed to provide basic audio functionality accompanying data presentations for business purposes only. It is not designed for, nor intended for stereo audio reproduction use as might be expected in home theater or home cinema applications. Any stereo audio input (if provided), is mixed into a common mono audio output through the projector speaker.

If you wish, you can make use of the projector (mixed mono) speaker in your presentations, and also connect separate amplified speakers to the Audio Out socket of the projector. The audio output is a mixed mono signal and controlled by the projector Volume and Mute settings.



If you have a separate sound system, you will most likely want to connect the audio output of your Video source device to that sound system, instead of to the mono audio projector.

## Connecting an HDMI device

You should use an HDMI cable when making connection between the projector and HDMI devices.

1. Take an HDMI cable and connect one end to the HDMI output port of the video device.
2. Connect the other end of the cable to the **HDMI** input port on the projector.

 **In the unlikely event that you connect the projector to a DVD player via the projector's HDMI input and the projected picture displays wrong colors, please change the color space to YUV. See "Changing HDMI input settings" on page 24 for details.**

 **The projector is only capable of playing mixed mono audio, even if a stereo audio input is connected. See "Connecting audio" on page 17 for details.**

## Connecting a Component Video source device

Examine your Video source device to determine if it has a set of unused Component Video output sockets available:

- If so, you can continue with this procedure.
  - If not, you will need to reassess which method you can use to connect to the device.
1. Take a VGA (D-Sub)-Component adaptor cable and connect the end with 3 RCA type connectors to the Component Video output sockets of the Video source device. Match the color of the plugs to the color of the sockets; green to green, blue to blue, and red to red.
  2. Connect the other end of the VGA (D-Sub)-Component adaptor cable (with a D-Sub type connector) to the **COMPUTER IN 1** or **COMPUTER IN 2** socket on the projector.

 **The projector is only capable of playing mixed mono audio, even if a stereo audio input is connected. See "Connecting audio" on page 17 for details.**

 **If the selected video image is not displayed after the projector is turned on and the correct video source has been selected, check that the Video source device is turned on and operating correctly. Also check that the signal cables have been connected correctly.**

  **VGA-Component adaptor  
(ViewSonic P/N: CB-00008906)**

## Connecting an S-Video source device

Examine your Video source device to determine if it has an unused S-Video output socket available:

- If so, you can continue with this procedure.
  - If not, you will need to reassess which method you can use to connect to the device.
1. Take an S-Video cable and connect one end to the S-Video output socket of the Video source device.
  2. Connect the other end of the S-Video cable to the **S-VIDEO** socket on the projector.

 **The projector is only capable of playing mixed mono audio, even if a stereo audio input is connected. See "Connecting audio" on page 17 for details.**

 **If the selected video image is not displayed after the projector is turned on and the correct video source has been selected, check that the Video source device is turned on and operating correctly. Also check that the signal cables have been connected correctly.**

☞ If you have already made a Component Video connection between the projector and this S-Video source device using Component Video connections, you need not connect to this device using an S-Video connection as this makes an unnecessary second connection of poorer picture quality. See ["Connecting Video source devices" on page 17](#) for details.

## Connecting a composite Video source device

Examine your Video source device to determine if it has a set of unused composite Video output sockets available:

- If so, you can continue with this procedure.
  - If not, you will need to reassess which method you can use to connect to the device.
1. Take a Video cable and connect one end to the composite Video output socket of the Video source device.
  2. Connect the other end of the Video cable to the **VIDEO** socket on the projector.

☞ **The projector is only capable of playing mixed mono audio, even if a stereo audio input is connected.** See ["Connecting audio" on page 17](#) for details.

☞ If the selected video image is not displayed after the projector is turned on and the correct video source has been selected, check that the Video source device is turned on and operating correctly. Also check that the signal cables have been connected correctly.

☞ You need only connect to this device using a composite Video connection if Component Video and S-Video inputs are unavailable for use. See ["Connecting Video source devices" on page 17](#) for details.

## Using the cable management cover (optional accessory)

This cable management cover helps you to conceal and organize the cables connected to the back of the projector. It is especially useful when the projector is ceiling-mounted or wall-mounted.

1. Make sure that all the cables are properly connected to the projector.
2. Attach the cable management cover to the back of the projector.
3. Tighten the screws that secure the cable management cover.

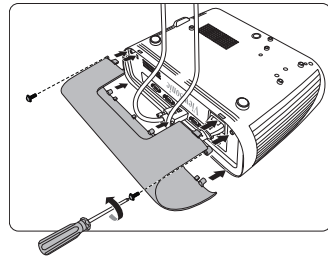

# Operation

## Starting up the projector

1. Plug the power cord into the projector and into a wall socket. Turn on the wall socket switch (where fitted).
2. Press **Power** to start the projector. As soon as the lamp lights up, a "Power On Ring Tone" will be heard. The **Power indicator light** stays blue when the projector is on.  
(If necessary) Rotate the focus ring to adjust the image clearness.

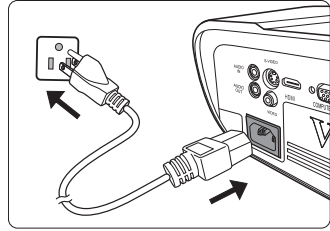

**☞ If the projector is still hot from previous activity, it will run the cooling fan for approximately 60 seconds before energizing the lamp.**

**☞ To maintain the lamp life, once you turn the projector on, wait at least 5 minutes before turning it off.**

**☞ To turn off the ring tone, see ["Turning off the Power On/Off Ring Tone"](#) on page 35 for details.**

3. If the projector is activated for the first time, select your OSD language following the on-screen instructions.
4. Switch all of the connected equipment on.
5. The projector will start to search for input signals. The current input signal being scanned appears in the upper left corner of the screen. If the projector doesn't detect a valid signal, the message '**No Signal**' will continue to be displayed until an input signal is found.

You can also press **Source** to select your desired input signal. See ["Switching input signal"](#) on page 24 for details.

**☞ If the frequency/resolution of the input signal exceeds the projector's operating range, you will see the message 'Out of Range' displayed on a blank screen. Please change to an input signal which is compatible with the projector's resolution or set the input signal to a lower setting. See ["Timing chart"](#) on page 56 for details.**

# Using the menus

The projector is equipped with On-Screen Display (OSD) menus for making various adjustments and settings.

 The OSD screenshots below are for reference only, and may differ from the actual design.

Below is the overview of the OSD menu.

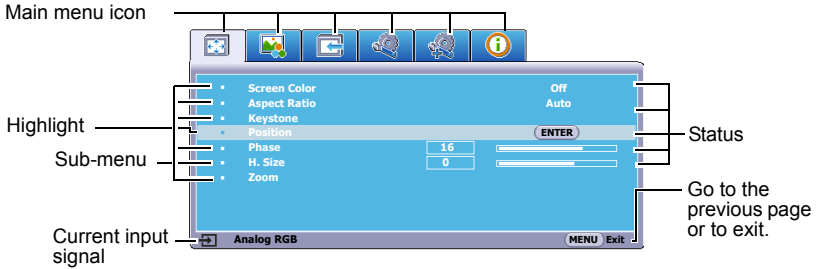

To use the OSD menus, please select your language first.

1. Press **Menu** to turn the OSD menu on.

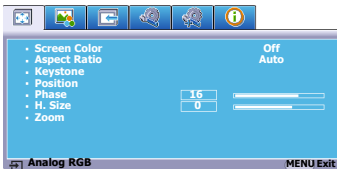

3. Press **▼** to highlight **Language** and press **◀/▶** to select a preferred language.

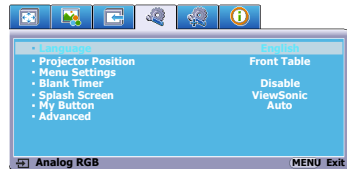



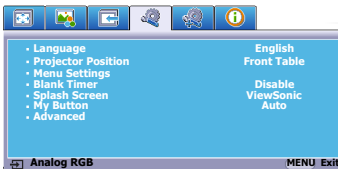



2. Use **◀/▶** to highlight the **SYSTEM SETTING: BASIC** menu.



4. Press **Exit** twice\* to leave and save the settings.

\*The first press leads you back to the main menu and the second press closes the OSD menu.

	: DISPLAY		: SYSTEM SETTING: BASIC
	: PICTURE		: SYSTEM SETTING: ADVANCED
	: SOURCE		: INFORMATION

# Utilizing the password function

For security purposes and to help prevent unauthorized use, the projector includes an option for setting up password security. The password can be set through the On-Screen Display (OSD) menu. For details of the OSD menu operation, please refer to "Using the menus" on page 21.

 You will be inconvenienced if you enable the password function yet forget the password somehow. Do make a note of your password, and keep the note in a safe place for later recall.

## Setting a password

 Once a password has been set and the power on lock is enabled, the projector cannot be used unless the correct password is entered every time the projector is started.

1. Open the OSD menu and go to the **SYSTEM SETTING: ADVANCED > Advanced > Security Settings** menu.
2. Press **Enter** and the **Security Settings** page is displayed.
3. Highlight **Power On Lock** and select **On** by pressing **◀/▶**.
4. As pictured to the right, the four arrow keys (**◀, ▲, ▼, ▶**) respectively represent 4 digits (1, 2, 3, 4). According to the password you desire to set, press the arrow keys to enter six digits for the password.
5. Confirm the new password by re-entering the new password.  
Once the password is set, the OSD menu returns to the **Security Settings** page.
6. To leave the OSD menu, press **Exit**.

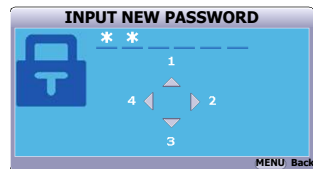

## If you forget the password

If the password function is activated, you will be asked to enter the six-digit password every time you turn on the projector. If you enter the wrong password, the password error message as pictured to the right is displayed lasting for 5 seconds, and the message 'INPUT PASSWORD' follows. You can retry by entering another six-digit password, or if you did not record the password in this user manual, and you absolutely do not remember it, you can use the password recall procedure. See "Entering the password recall procedure" on page 23 for details.

If you enter an incorrect password 5 times in succession, the projector will automatically shut down in a short time.

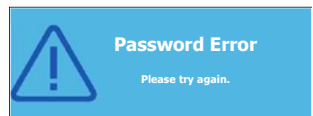

## Entering the password recall procedure

1. Press and hold **Auto Sync** on the remote control for 3 seconds. The projector will display a coded number on the screen.
2. Write down the number and turn off your projector.
3. Seek help from the local service center to decode the number. You may be required to provide proof of purchase documentation to verify that you are an authorized user of the projector.

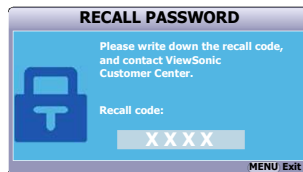

 The "XXX" shown in the above screenshot are numbers that vary depending on different projector models.

## Changing the password

1. Open the OSD menu and go to the **SYSTEM SETTING: ADVANCED > Advanced > Security Settings > Change Password** menu.
2. Press **Enter**. The message 'INPUT CURRENT PASSWORD' is displayed.
3. Enter the old password.
  - If the password is correct, another message 'INPUT NEW PASSWORD' is displayed.
  - If the password is incorrect, the password error message is displayed lasting for 5 seconds, and the message 'INPUT CURRENT PASSWORD' is displayed for your retry. You can press **Exit** to cancel or try another password.
4. Enter a new password.
5. Confirm the new password by re-entering the new password.
6. You have successfully assigned a new password to the projector. Remember to enter the new password next time the projector is started.
7. To leave the OSD menu, press **Exit**.

 The digits being input will be displayed as asterisks on-screen. Do make a note of your password, and then keep the note in a safe place for later recall.

## Disabling the password function

1. Open the OSD menu and go to the **SYSTEM SETTING: ADVANCED > Advanced > Security Settings > Power On Lock** menu.
2. Press **◀/▶** to select **Off**.
3. The message 'INPUT PASSWORD' is displayed. Enter the current password.
  - If the password is correct, the OSD menu returns to the **Security Settings** page with '**Off**' shown in the row of **Power On Lock**. You will not have to enter the password next time you turn on the projector.
  - If the password is incorrect, the password error message is displayed lasting for 5 seconds, and the message 'INPUT PASSWORD' is displayed for your retry. You can press **Exit** to cancel or try another password.

 Though the password function is disabled, you need to keep the old password in hand should you ever need to re-activate the password function by entering the old password.

# Switching input signal

The projector can be connected to multiple devices at the same time. However, it can only display one full screen at a time.

Be sure the **Quick Auto Search** function in the **SOURCE** menu is **On** if you want the projector to automatically search for the signals.

You can also manually select the desired signal by pressing one of the source selection keys on the remote control, or cycle through the available input signals.

1. Press **Source**. A source selection bar is displayed.
2. Press **▲ / ▼** until your desired signal is selected and press **Enter**.  
Once detected, the selected source information will be displayed on the screen for seconds. If there are multiple devices connected to the projector, repeat steps 1-2 to search for another signal.

 The brightness level of the projected image will change accordingly when you switch between different input signals. Data (graphic) "PC" presentations using mostly static images are generally brighter than "Video" using mostly moving images (movies).

 The input signal type affects the options available for the Color Mode. See ["Selecting a picture mode" on page 28](#) for details.

 Please see ["Projector specifications" on page 53](#) for the native display resolution of this projector. For best display picture results, you should select and use an input signal which outputs at this resolution. Any other resolutions will be scaled by the projector depending upon the 'aspect ratio' setting, which may cause some image distortion or loss of picture clarity. See ["Selecting the aspect ratio" on page 27](#) for details.

## Changing HDMI input settings

In the unlikely event that you connect the projector to a device (like a DVD or Blu-ray player) via the projector's **HDMI** input and the projected picture displays wrong colors, please change the color space to an appropriate one that fits the color space setting of the output device.

To do this:

1. Open the OSD menu and go to the **PICTURE > HDMI Settings** menu.
2. Press **Enter**.
3. Highlight **HDMI Format** and press **◀ / ▶** to select a suitable color space according to the color space setting of the output device connected.

PJD5155/PJD5255/PJD5555w

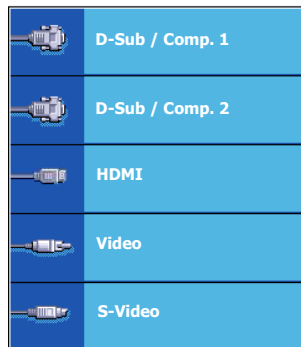

PJD5153/PJD5253



PJD5151/PJD5250

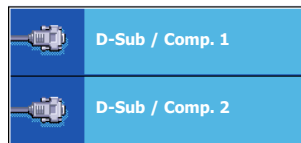

- **RGB:** Sets the color space as RGB.
  - **YUV:** Sets the color space as YUV.
  - **Auto:** Sets the projector to detect the color space setting of the input signal automatically.
4. Highlight **HDMI Range** and press ◀/▶ to select a suitable HDMI color range according to the color range setting of the output device connected.
- **Enhanced:** Sets the HDMI color range as 0 - 255.
  - **Normal:** Sets the HDMI color range as 15 - 235.
  - **Auto:** Sets the projector to detect the HDMI range of the input signal automatically.

☞ This function is only available when the HDMI input port is in use.

☞ Refer to the documentation of the device for information on the color space and HDMI range settings.

## Adjusting the projected image

### Adjusting the projection angle

The projector is equipped with an adjuster foot. It changes the image height and vertical projection angle. Screw the adjuster foot to fine tune the angle until the image is positioned where you want it.

If the projector is not placed on a flat surface or the screen and the projector are not perpendicular to each other, the projected image becomes trapezoidal. To correct this situation, see "[Correcting keystone](#)" on page 26 for details.

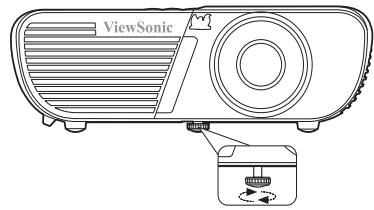

⚠ Do not look into the lens while the lamp is on. The strong light from the lamp may cause damage to your eyes.

### Auto-adjusting the image

In some cases, you may need to optimize the picture quality. To do this, press **Auto Sync** on the remote control. Within 3 seconds, the built-in Intelligent Auto Adjustment function will re-adjust the values of Frequency and Clock to provide the best picture quality.

The current source information will be displayed in the upper left corner of the screen for 5 seconds.

☞ The screen will be blank while auto adjustment is functioning.

☞ This function is only available when PC D-Sub input signal (analog RGB) is selected.



## Fine-tuning the image clarity

1. Adjust the projected image to the size that you need using the zoom ring.
2. If necessary, sharpen the image by rotating the focus ring.

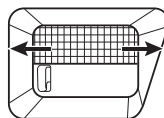
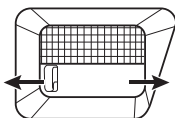
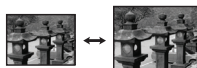

## Correcting keystone

Keystoning refers to the situation where the projected image is noticeably wider at either the top or bottom. It occurs when the projector is not perpendicular to the screen.

To correct this, besides adjusting the height of the projector, you will need to manually correct it following one of these steps.

- Using the remote control

Press  $\Delta$ / $\square$  to display the Keystone correction page. Press  $\Delta$  to correct keystoning at the top of the image. Press  $\square$  to correct keystoning at the bottom of the image.



- Using the OSD menu

1. Open the OSD menu and go to the **DISPLAY > Keystone** menu.
2. Press **Enter**. The **Keystone** correction page is displayed.
3. Press  $\Delta$  to correct keystoning at the top of the image or press  $\square$  to correct keystoning at the bottom of the image.

## Magnifying and searching for details

If you need to find the details on the projected picture, magnify the picture. Use the direction arrow keys for navigating the picture.

- Using the remote control

1. Press  $\text{Q}$  on the remote control to display the Zoom bar.
2. Press  $\blacktriangle$  repeatedly to magnify the picture to a desired size.
3. To navigate the picture, press **Enter** to switch to the panning mode and press the directional arrows ( $\blacktriangleleft$ ,  $\blacktriangle$ ,  $\blacktriangledown$ ,  $\blacktriangleright$ ) to navigate the picture.
4. To reduce size of the picture, press **Enter** to switch back to the zoom in/out functionality, and press  $\blacktriangledown$  repeatedly until it is restored to the original size. You can also press **Auto Sync** on the remote control to restore the picture to its original size.

- Using the OSD menu

1. Open the OSD menu and go to the **DISPLAY > Zoom** menu.
2. Press **Enter**. The Zoom bar is displayed.
3. Repeat steps 2-4 in the section of Using the remote control above.

 This function is only available when a PC input signal is selected.

 The picture can only be navigated after it is magnified. You can further magnify the picture while searching for details.

## Selecting the aspect ratio

The 'aspect ratio' is the ratio of the image width to the image height. Most analog TV and computers are in 4:3 ratio, and digital TV and DVDs are usually in 16:9 ratio.

With the advent of digital signal processing, digital display devices like this projector can dynamically stretch and scale the image output to a different aspect than that of the image input signal.

To change the projected image ratio (no matter what aspect the source is):

1. Open the OSD menu and go to the **DISPLAY > Aspect Ratio** menu.
2. Press **◀/▶** to select an aspect ratio to suit the format of the video signal and your display requirements.

### About the aspect ratio

 In the pictures below, the black portions are inactive areas and the white portions are active areas. OSD menus can be displayed on those unused black areas.

1. **Auto**: Scales an image proportionally to fit the projector's native resolution in its horizontal width. This is suitable for the incoming image which is neither in 4:3 nor 16:9 and you want to make most use of the screen without altering the image's aspect ratio.

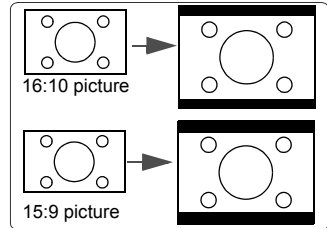

2. **4:3**: Scales an image so that it is displayed in the center of the screen with a 4:3 aspect ratio. This is most suitable for 4:3 images like computer monitors, standard definition TV and 4:3 aspect DVD movies, as it displays them without aspect alteration.

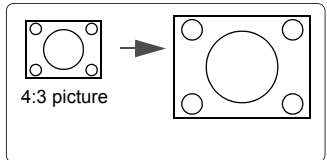

3. **16:9**: Scales an image so that it is displayed in the center of the screen with a 16:9 aspect ratio. This is most suitable for images which are already in a 16:9 aspect, like high definition TV, as it displays them without aspect alteration.

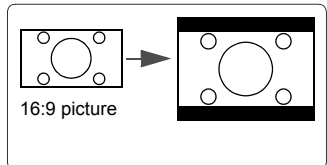

4. **16:10 (PJD5555w)**: Scales an image so that it is displayed in the center of the screen with a 16:10 aspect ratio. This is most suitable for images which are already in a 16:10 aspect, as it displays them without aspect alteration.

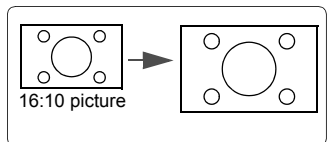

5. **Wide (PJD5555w)**: Scales a 4:3 aspect image vertically and horizontally in a non-linear manner so that it fills the screen with a 16:9 aspect ratio.

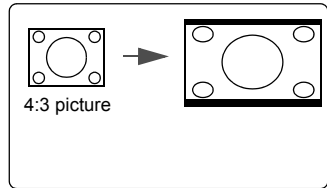

6. **Panorama (PJD5151/PJD5153/PJD5155/PJD5250/PJD5253/PJD5255)**: Scales a 4:3 image vertically and horizontally in a non-linear manner so that it fills the screen..

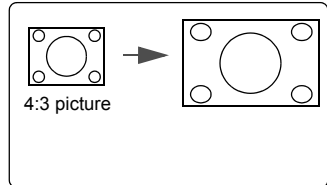

7. **2.35:1 (PJD5155/PJD5255/PJD5555w)**: Scales an image so that it is displayed in the center of the screen with a 2.35:1 aspect ratio without aspect alteration.

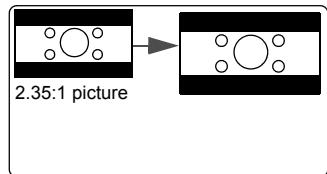

8. **Anamorphic (PJD5155/PJD5255/PJD5555w)**: Scales a 2.35:1 aspect image so that it fills the screen.

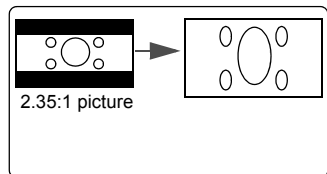

## Optimizing the image

### Selecting a picture mode

The projector is preset with several predefined picture modes so that you can choose one to suit your operating environment and input signal picture type.

To select an operation mode that suits your need, you can follow one of the following steps.

- Press **Color Mode** repeatedly until your desired mode is selected.
- Go to the **PICTURE > Color Mode** menu and press ◀/▶ to select a desired mode.

### Picture modes for different types of signals

The picture modes available for different types of signals are listed below.

1. **Brightest mode**: Maximizes the brightness of the projected image. This mode is suitable for environments where extra-high brightness is required, such as using the projector in well lit rooms.
2. **Dynamic mode**: Is designed for presentations under daylight environment to match PC and notebook coloring. In addition, the projector will optimize the image quality using the dynamic PC function in accordance with the projected contents.

3. **Standard mode:** Is designed for presentations under daylight environment to match PC and notebook coloring.
4. **ViewMatch mode:** Switches between high brightness performance and accurate color performance.
5. **Movie mode:** Is appropriate for playing colorful movies, video clips from digital cameras or DVs through the PC input for best viewing in a blackened (little light) environment.

## Using Screen Color

In the situation where you are projecting onto a colored surface such as a painted wall which may not be white, the **Screen Color** feature can help correct the projected picture's colors to prevent possible color difference between the source and projected pictures.

To use this function, go to the **DISPLAY > Screen Color** menu and press ◀/▶ to select a color which is closest to the color of the projection surface. There are several precalibrated colors to choose from: **Whiteboard**, **Greenboard**, and **Blackboard**.

 This function is only available when a PC input signal is selected.

## Fine-tuning the image quality in user modes

According to the detected signal type, there are some user-definable functions available. You can make adjustments to these functions based on your needs.

### Adjusting Brightness

Go to the **PICTURE > Brightness** menu and press ◀/▶.

The higher the value, the brighter the image. And the lower the setting, the darker the image. Adjust this control so the black areas of the image appear just as black and that detail in the dark areas is visible.



### Adjusting Contrast

Go to the **PICTURE > Contrast** menu and press ◀/▶.

The higher the value, the greater the contrast. Use this to set the peak white level after you have previously adjusted the **Brightness** setting to suit your selected input and viewing environment.



### Adjusting Color

Go to the **PICTURE > Advanced > Color** menu and press ◀/▶.

Lower setting produces less saturated colors. If the setting is too high, colors on the image will be overpowering, which makes the image unrealistic.

### Adjusting Tint

Go to the **PICTURE > Advanced > Tint** menu and press ◀/▶.

The higher the value, the more reddish the picture becomes. The lower the value, the more greenish the picture becomes.

### Adjusting Sharpness

Go to the **PICTURE > Advanced > Sharpness** menu and press ◀/▶.

The higher the value, the sharper the picture becomes. The lower the value, the softer the picture becomes.

## Adjusting Brilliant Color

Go to the **PICTURE > Advanced > Brilliant Color** menu and press ◀/▶.

This feature utilizes a new color-processing algorithm and system level enhancements to enable higher brightness while providing truer, more vibrant colors in the projected picture. It enables a greater than 50% brightness increase in mid-tone images, which are common in video and natural scenes, so the projector reproduces images in realistic and true colors. If you prefer images with that quality, select a level that suits your need. If you don't need it, select **Off**.

When **Off** is selected, the **Color Temp.** function is not available.

## Reducing image noise

Go to the **PICTURE > Advanced > Noise Reduction** menu and press ◀/▶.

This function reduces electrical image noise caused by different media players. The higher the setting, the less the noise.

## Selecting a gamma setting

Go to the **PICTURE > Advanced > Gamma** menu and select a preferred setting by pressing ◀/▶.

Gamma refers to the relationship between input source and picture brightness.

## Selecting a Color Temperature

Go to the **PICTURE > Color Temp.** menu and press ◀/▶.

The options available for color temperature\* settings vary according to the signal type selected.

1. **Cool:** With the highest color temperature, **Cool** makes the image appear the most bluish white than other settings.
2. **Neutral:** Makes images appear bluish white.
3. **Normal:** Maintains normal colorings for white.
4. **Warm:** Makes images appear reddish white.

### \*About color temperatures:

There are many different shades that are considered to be "white" for various purposes. One of the common methods of representing white color is known as the "color temperature". A white color with a low color temperature appears to be reddish white. A white color with a high color temperature appears to have more blue in it.

## Setting a preferred color temperature

1. Go to the **PICTURE > Color Temp.** menu.
2. Press ◀/▶ to select **Cool**, **Neutral**, **Normal** or **Warm** and press **Enter**.
3. Press ▲/▼ to highlight the item you want to change and adjust the values by pressing ◀/▶.
  - **Red Gain/Green Gain/Blue Gain:** Adjusts the contrast levels of Red, Green, and Blue.
  - **Red Offset/Green Offset/Blue Offset:** Adjusts the brightness levels of Red, Green, and Blue.

 This function is only available when a PC input signal is selected.

## Color Management

Only in permanent installations with controlled lighting levels such as boardrooms, lecture theaters, or home theaters, should color management be considered. Color management provides fine color control adjustment to allow for more accurate color reproduction, should you require it.

If you have purchased a test disc which contains various color test patterns and can be used to test the color presentation on monitors, TVs, projectors, etc., you can project any image from the disc on the screen and enter the **Color Management** menu to make adjustments.

### To adjust the settings:

1. Open the OSD menu and go to the **PICTURE > Advanced > Color Management** menu.
2. Press **Enter** and the **Color Management** page is displayed.
3. Highlight **Primary Color** and press **◀/▶** to select a color from among Red, Yellow, Green, Cyan, Blue, or Magenta.
4. Press **▼** to highlight **Hue** and press **◀/▶** to select its range. Increase in the range will include colors consisted of more proportions of its two adjacent colors.

Please refer to the illustration to the right for how the colors relate to each other.

For example, if you select Red and set its range at 0, only pure red in the projected picture will be selected. Increasing its range will include red close to yellow and red close to magenta.

5. Press **▼** to highlight **Saturation** and adjust its values to your preference by pressing **◀/▶**. Every adjustment made will reflect to the image immediately.

For example, if you select Red and set its value at 0, only the saturation of pure red will be affected.

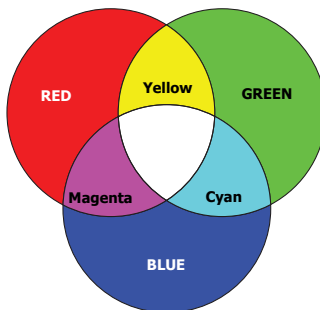

 **Saturation is the amount of that color in a video picture. Lower settings produce less saturated colors; a setting of “0” removes that color from the image entirely. If the saturation is too high, that color will be overpowering and unrealistic.**

6. Press **▼** to highlight **Gain** and adjust its values to your preference by pressing **◀/▶**. The contrast level of the primary color you select will be affected. Every adjustment made will reflect to the image immediately.
7. Repeat steps 3 to 6 for other color adjustments.
8. Make sure you have made all of the desired adjustments.
9. Press **Exit** to exit and save the settings.

## Setting the presentation timer

Presentation timer can indicate the presentation time on the screen to help you achieve better time management when giving presentations. Follow these steps to utilize this function:

1. Press **⏸** on the remote control to access the **Presentation Timer** menu or go to the **SYSTEM SETTING: BASIC > Advanced > Presentation Timer** menu.
2. Press **Enter** to display the **Presentation Timer** page.

- Highlight **Timer Period** and decide the time period by pressing ◀/▶. The length of time can be set from 1 to 5 minutes in 1-minute increments and 5 to 240 minutes in 5-minute increments.

 If the timer is already on, the timer will restart whenever the **Timer Period** is reset.

- Press ▼ to highlight **Timer Display** and choose if you want the timer to show up on the screen by pressing ◀/▶.

Selection	Description
Always	Displays the timer on screen throughout the presentation time.
1 min/2 min/3 min	Displays the timer on screen in the last 1/2/3 minute(s).
Never	Hides the timer throughout the presentation time.

- Press ▼ to highlight **Timer Position** and set the timer position by pressing ◀/▶.

Top-Left → Bottom-Left → Top-Right → Bottom-Right

- Press ▼ to highlight **Timer Counting Direction** and select your desired counting direction by pressing ◀/▶.

Selection	Description
<b>Count Up</b>	Increases from 0 to the preset time.
<b>Count Down</b>	Decreases from the preset time to 0.

- Press ▼ to highlight **Sound Reminder** and decide if you want to activate sound reminder by pressing ◀/▶. If you select **On**, a double beep sound will be heard at the last 30 seconds of counting down/up, and a triple beep sound will be produced when the timer is up.
- To activate the presentation timer, press ▼ and press ◀/▶ to highlight **Start Counting** and press **Enter**.
- A confirmation message displays. Highlight **Yes** and press **Enter** to confirm. You will see the message “**Timer is On**” displaying on the screen. The timer starts counting when the timer is on.

### To cancel the timer, perform the following steps:

- Go to the **SYSTEM SETTING: BASIC > Advanced > Presentation Timer** menu.
- Highlight **Off**. Press **Enter**. A confirmation message displays.
- Highlight **Yes** and press **Enter** to confirm. You will see the message “**Timer is Off**” displaying on the screen.

## Hiding the image

In order to draw the audience's full attention to the presenter, you can press **Blank** to hide the screen image. Press any key on the projector or remote control to restore the image. The word '**BLANK**' appears at the lower right corner of the screen while the image is hidden.

You can set the blank time in the **SYSTEM SETTING: BASIC > Blank Timer** menu to let the projector return the image automatically after a period of time when there is no action taken on the blank screen.



 Once Blank is pressed, the projector enters Economic mode automatically.

### CAUTION

Do not block the projection lens from projecting as this could cause the blocking object to become heated and deformed or even cause a fire.

## Locking control keys



With the control keys on the projector locked, you can prevent your projector settings from being changed accidentally (by children, for example). When the **Panel Key Lock** is on, no control keys on the projector will operate except  **Power**.

1. Press  (**Panel Key Lock**), or go to the **SYSTEM SETTING: ADVANCED > Advanced > Panel Key Lock** menu
2. Press  to select **On**.
3. A confirmation message is displayed. Select **Yes** to confirm.

To release panel key lock, press and hold  for 3 seconds.

You can also use the remote control to enter the **SYSTEM SETTING: ADVANCED > Advanced > Panel Key Lock** menu and press  to select **Off**.

 Keys on the remote control are still functional when panel key lock is enabled.

 If you press  **Power** to turn off the projector without disabling panel key lock, the projector will still be in locked status the next time it is turned on.

## Operating in a high altitude environment

We recommend you use the **High Altitude Mode** when your environment is between 1500 m–3000 m above sea level, and temperature is between 5°C–25°C.

### CAUTION

Do not use the High Altitude Mode if your altitude is between 0 m and 1500 m and temperature is between 5°C and 35°C. The projector will be over cooled, if you turn the mode on under such a condition.

To activate the **High Altitude Mode**:

1. Open the OSD menu and go to the **SYSTEM SETTING: ADVANCED > High Altitude Mode** menu.
2. Press  to select **On**. A confirmation message is displayed.
3. Highlight **Yes** and press **Enter**.

Operation under "**High Altitude Mode**" may cause a higher decibel operating noise level because of increased fan speed necessary to improve overall system cooling and performance.

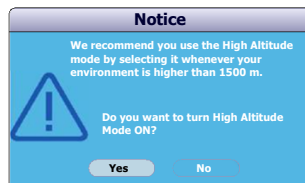



If you use this projector under other extreme conditions excluding the above, it may display auto shut-down symptoms, which is designed to protect your projector from over-heating. In cases like this, you should switch to **High Altitude Mode** to solve these symptoms. However, this is not to state that this projector can operate under any and all harsh or extreme conditions.

## Using the CEC function

This projector supports CEC (Consumer Electronics Control) function for synchronized power on/off operation via HDMI connection. That is, if a device that also supports CEC function is connected to the HDMI input of the projector, when the projector's power is turned off, the power of the connected device will also be turned off automatically. When the power of the connected device is turned on, the projector's power will be turned on automatically.

To turn on the CEC function:

1. Open the OSD menu and go to the **SOURCE > Auto Power On > CEC** menu.
2. Press **◀/▶** to select **Enable**.

 **In order for the CEC function to work properly, make sure that the device is correctly connected to the HDMI input of the projector via an HDMI cable, and its CEC function is turned on.**

 **Depending on the connected device, the CEC function may not work.**

## Using the 3D functions

This projector features 3D function which enables you to enjoy 3D movies, videos, and sporting events in a more realistic way by presenting the depth of the images. You need to wear a pair of 3D glasses to view 3D images.

If the 3D signal is input from an HDMI 1.4a compatible device, the projector detects the signal for **3D Sync** information and once detected, it projects images in 3D format automatically. In other cases, you may need to manually select a **3D Sync** format for the projector to project 3D images correctly.

To select a **3D Sync** format:

1. Press **3D** on the remote control to access the **3D Settings** menu or go to the **SOURCE > 3D Settings** menu.
2. Press **Enter** and the **3D Settings** page is displayed.
3. Highlight **3D Sync** and press **Enter**.
4. Press **▼** to select a **3D Sync** setting and then press **Enter** to confirm.

 **When the 3D Sync function is on:**

- **The brightness level of the projected image will decrease.**
- **The Color Mode cannot be adjusted.**
- **The Zoom function can only magnify the pictures to limited sizes.**

**If you discover the inversion of the 3D image depth, set the 3D Sync Invert function to "Invert" to correct the problem.**

# Using the projector in standby mode

Some of the projector functions are available in standby mode (plugged in but not turned on). To use these functions, be sure you have turned on the corresponding menus under **SOURCE > Standby Settings**, and the cable connections are correctly made. For the connection methods, see the [Connection](#) chapter.

## Active VGA Out

Selecting **On** outputs a VGA signal when the **COMPUTER IN 1** and **COMPUTER OUT** sockets are correctly connected to devices. The projector outputs the signal received only from **COMPUTER IN 1**.

## Active Audio Out



Selecting **On** outputs an audio signal when the **AUDIO IN** and **AUDIO OUT** sockets are correctly connected to devices.

# Adjusting the sound

The sound adjustments made as below will have an effect on the projector speaker. Be sure you have made a correct connection to the projector audio input/output jacks. See "[Connection](#)" on page 15 for more details.



## Muting the sound

1. Open the OSD menu and go to the **SYSTEM SETTING: ADVANCED > Audio Settings > Mute** menu.
2. Press ◀/▶ to select **On**.

 If available, you can press  on the remote control to toggle the projector audio between on and off.

## Adjusting the sound level

1. Open the OSD menu and go to the **SYSTEM SETTING: ADVANCED > Audio Settings > Audio Volume** menu.
2. Press ◀/▶ to select a desired sound level.

 If available, you can press  or  on the remote control to adjust the projector's sound level.

## Turning off the Power On/Off Ring Tone

1. Open the OSD menu and go to the **SYSTEM SETTING: ADVANCED > Audio Settings > Power On/Off Ring Tone** menu.
2. Press ◀/▶ to select **Off**.

 The only way to change Power On/Off Ring Tone is setting On or Off here. Setting the sound mute or changing the sound level will not affect the Power On/Off Ring Tone.

# Shutting down the projector

1. Press **Power** and a confirmation message is displayed prompting you.  
If you don't respond in a few seconds, the message will disappear.
2. Press **Power** a second time.
3. Once the cooling process finishes, a "Power Off Ring Tone" will be heard. Disconnect the power cord from the wall socket if the projector will not be used in an extended period of time.

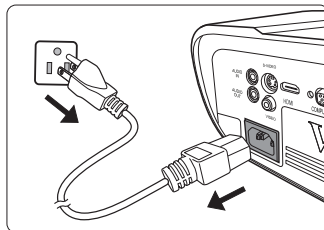

 To turn off the ring tone, see ["Turning off the Power On/Off Ring Tone" on page 35](#) for details.

## CAUTION

- To protect the lamp, the projector will not respond to any commands during the cooling process.
- To shorten the cooling time, you can also activate the Quick Power Off function. See ["Quick Power Off" on page 42](#) for details.
- Do not unplug the power cord before the projector shutdown sequence is complete.

# Menu operation

## Menu system

Please note that the on-screen display (OSD) menus vary according to the signal type selected.







The menu items are available when the projector detects at least one valid signal. If there is no equipment connected to the projector or no signal detected, limited menu items are accessible.

Main menu	Sub-menu	Options	
1. DISPLAY	Screen Color	Off/Blackboard/Greenboard/Whiteboard	
	Aspect Ratio	Auto/4:3/16:9/16:10 (PJD5555w)/Wide (PJD5555w)/Panorama (PJD5151/PJD5153/PJD5155/PJD5250/PJD5253/PJD5255)/2.35:1 (PJD5155/PJD5255/PJD5555w)/Anamorphic (PJD5155/PJD5255/PJD5555w)	
	Keystone		
	Position		
	Phase		
	H. Size		
	Zoom		
	2. PICTURE	Color Mode	Brightest/Dynamic/Standard/ViewMatch/Movie
Brightness			
Contrast			
Color Temp.		Warm	
		Normal	Red Gain/Green Gain/Blue Gain/Red Offset/
		Neutral	Green Offset/Blue Offset
		Cool	
OverScan		Off/1/2/3/4/5	
HDMI Settings		HDMI Format	Auto/RGB/YUV
		HDMI Range	Auto/Enhanced/Normal
Advanced		Color	
		Tint	
		Sharpness	
		Gamma	1/2/3/4/5/6/7/8
		Brilliant Color	Off/1/2/3/4/5/6/7/8/9/10
		Noise Reduction	
		Color Management	Primary Color
	Hue		
Saturation			
	Gain		
Reset Color Settings	Reset/Cancel		

Main menu	Sub-menu	Options	
3. SOURCE	Quick Auto Search	Off/On	
	3D Settings	3D Sync	Auto/Off/Frame Sequential/ Frame Packing/Top-Bottom/ Side-By-Side
		3D Sync Invert	Disable/Invert
	Standby Settings	Active VGA Out	Off/On
		Active Audio Out	Off/On
	Auto Power On	Computer	Disable/Enable
		CEC	Disable/Enable
		Direct Power On	Off/On
	Auto Power Off	Power Saving	Disable/10 min/20 min/30 min
		Sleep Timer	Disable/30 min/1 hr /2 hr/3 hr/ 4 hr/8 hr/12 hr
Smart Restart		Disable/Enable	
Quick Power Off		Disable/Enable	
4. SYSTEM SETTING: BASIC	Language	Multi-language OSD selection	
	Projector Position	Front Table/Rear Table/ Rear Ceiling/Front Ceiling	
	Menu Settings	Menu Display Time	5 sec/10 sec/15 sec/20 sec/ 25 sec/30 sec
		Menu Position	Center/Top-Left/Top-Right/ Bottom-Left/Bottom-Right
	Blank Timer	Disable/5 min/10 min/15 min/ 20 min/25 min/30 min	
	Splash Screen	Black/Blue/ViewSonic/Off	
	My Button	Auto/Projection (Projector Position)/Menu Position/Color Temp./Brightness/Contrast/3D Settings/Screen Color/Splash Screen/Message/Quick Auto Search/CEC/Lamp Mode/DCR/Closed Caption/Power Saving/Freeze/INFORMATION	
		Pattern	Off/01/02/03/04/05
	Advanced	Message	On/Off
		Presentation Timer	
			Timer Display
			Timer Position
			Timer Counting Direction
			Sound Reminder
	Start Counting/Off		





Main menu	Sub-menu	Options	
5. SYSTEM SETTING: ADVANCED	High Altitude Mode	On/Off	
	DCR	On/Off	
	Audio Settings	Mute	On/Off
		Audio Volume	
		Power On/Off Ring Tone	On/Off
	Closed Caption	Off/CC1/CC2/CC3/CC4	
	Lamp Settings	Lamp Mode	Normal/Economic/ Dynamic/Sleep Mode
		Reset Lamp Hours	
		Lamp Hours	
	Filter Settings	Filter Mode	On/Off
		Reset Filter Hours	
		Filter Hours	
	Remote Control Code	1/2/3/4/5/6/7/8 (All)	
Advanced	Security Settings	Change Password Power On Lock	
	Panel Key Lock	Off/On	
Reset Settings	Reset/Cancel		
6. INFORMATION	Current System Status	<ul style="list-style-type: none"> <li>• Source</li> <li>• Color Mode</li> <li>• Resolution</li> <li>• Color System</li> <li>• Lamp Hours</li> <li>• Filter Hours</li> <li>• Firmware Version</li> </ul>	



## Description of each menu



	Function	Description
1. DISPLAY menu	Screen Color	See <a href="#">"Using Screen Color"</a> on page 29 for details.  <b>This function is only available when a PC input signal is selected.</b>
	Aspect Ratio	See <a href="#">"Selecting the aspect ratio"</a> on page 27 for details.
	Keystone	See <a href="#">"Correcting keystone"</a> on page 26 for details.
	Position	Displays the position adjustment page. To move the projected image, use the directional arrow keys. The values shown on the lower position of the page change with every key press you made until they reach their maximum or minimum.  <b>This function is only available when a PC input signal is selected.</b>  <b>The adjustment range may vary under different timings.</b>
	Phase	Adjusts the clock phase to reduce image distortion.  <b>This function is only available when a PC input signal is selected.</b> 
	H. Size	Adjusts the horizontal width of the image.  <b>This function is only available when a PC input signal is selected.</b>
	Zoom	See <a href="#">"Magnifying and searching for details"</a> on page 26 for details.
2. PICTURE menu	Color Mode	See <a href="#">"Selecting a picture mode"</a> on page 28 for details.
	Brightness	See <a href="#">"Adjusting Brightness"</a> on page 29 for details.
	Contrast	See <a href="#">"Adjusting Contrast"</a> on page 29 for details.
	Color Temp.	See <a href="#">"Selecting a Color Temperature"</a> on page 30 and <a href="#">"Setting a preferred color temperature"</a> on page 30 for details.
	OverScan	Adjusts the overscan rate from 0% to 5%.  <b>This function is only available when a Composite video, S-Video or HDMI input signal is selected.</b>
	HDMI Settings	See <a href="#">"Changing HDMI input settings"</a> on page 24 for details.

	Function	Description
2. PICTURE menu	Advanced	<p><b>Color</b> See "Adjusting Color" on page 29 for details.</p> <p><b>Tint</b> See "Adjusting Tint" on page 29 for details.</p> <p> <b>This function is only available when a Composite video or S-Video input signal with NTSC system is selected.</b></p> <p><b>Sharpness</b> See "Adjusting Sharpness" on page 29 for details.</p> <p><b>Gamma</b> See "Selecting a gamma setting" on page 30 for details.</p> <p><b>Brilliant Color</b> See "Adjusting Brilliant Color" on page 30 for details.</p> <p><b>Noise Reduction</b> See "Reducing image noise" on page 30 for details.</p> <p><b>Color Management</b> See "Color Management" on page 31 for details.</p>
	Reset Color Settings	Returns all color settings to the factory preset values.
	Quick Auto Search	See "Switching input signal" on page 24 for details.
3. SOURCE menu	3D Settings	See "Using the 3D functions" on page 34 for details.
	Standby Settings	See "Using the projector in standby mode" on page 35 for details.
	Auto Power On	<p><b>Computer</b> Selecting <b>Enable</b> allows the projector to turn on automatically once the VGA signal is fed through the VGA cable.</p> <p><b>CEC</b> See "Using the CEC function" on page 34 for details.</p> <p><b>Direct Power On</b> Selecting <b>On</b> allows the projector to turn on automatically once the power is fed through the power cord.</p>



Function	Description
3. SOURCE menu	<p><b>Auto Power Off</b></p> <p><b>Power Saving</b> See "Setting Power Saving" on page 48 for details.</p> <p><b>Sleep Timer</b> See "Setting Sleep Timer" on page 48 for details.</p>
	<p><b>Smart Restart</b></p> <p>Selecting <b>Enable</b> enables you to restart the projector immediately within 120 seconds after turning it off. After 120 seconds, if the projector is not turned on again, it will directly enter the standby mode.</p> <p> <b>It takes some time to initiate this function. Make sure the projector has been turned on for more than 4 minutes. If the projector is resumed by using the Smart Restart feature, this function can be executed immediately.</b></p> <p> <b>When Enable is selected, the Quick Power Off function will be automatically set to "Enable".</b></p>
	<p><b>Quick Power Off</b></p> <p>Selecting <b>Enable</b> enables the function and the projector will not enter the cooling process after being shut down. Selecting <b>Disable</b> disables the function and the projector will enter normal cooling process after being shut down.</p> <p> <b>If you attempt to restart the projector right after it's been turned off, it may not be turned on successfully and will rerun its cooling procedure.</b></p> <p> <b>When Disable is selected, the Smart Restart function will be automatically turned off.</b></p>
4. SYSTEM SETTING: BASIC menu	<p><b>Language</b></p> <p>Sets the language for the On-Screen Display (OSD) menus. See "Using the menus" on page 21 for details.</p>
	<p><b>Projector Position</b></p> <p>See "Choosing a location" on page 12 for details.</p>
	<p><b>Menu Settings</b></p> <p><b>Menu Display Time</b> Sets the length of time the OSD will remain active after your last key press. The range is from 5 to 30 seconds in 5-second increments.</p> <p><b>Menu Position</b> Sets the On-Screen Display (OSD) menu position.</p>
	<p><b>Blank Timer</b></p> <p>See "Hiding the image" on page 33 for details.</p>

	Function	Description
4. SYSTEM SETTING: BASIC menu	<b>Splash Screen</b>	Allows you to select which screen will be displayed during projector start-up.
	<b>My Button</b>	Sets a hotkey on remote control.
	<b>Advanced</b>	<p><b>Pattern</b> The projector can display several test patterns. It helps you adjust the image size and focus and check that the projected image is free from distortion.</p> <p><b>Message</b> Selecting <b>On</b> displays the current information on the screen when the projector is detecting or searching for a signal.</p> <p><b>Presentation Timer</b> See "<a href="#">Setting the presentation timer</a>" on page 31 for details.</p>
5. SYSTEM SETTING: ADVANCED menu	<b>High Altitude Mode</b>	See " <a href="#">Operating in a high altitude environment</a> " on page 33 for details.
	<b>DCR</b>	<p>Enables or disables the DCR (Dynamic Contrast Ratio) function. Selecting <b>On</b> enables the function and the projector will automatically switch the lamp mode between normal and economic modes according to the input image detected.</p> <p> <b>This function is only available when a PC input signal is selected.</b></p> <p> <b>After enabling DCR, frequent lamp mode switching may shorten lamp life and noise level will vary during operation.</b></p>
	<b>Audio Settings</b>	See " <a href="#">Adjusting the sound</a> " on page 35 for details.

Function	Description
5. SYSTEM SETTING: ADVANCED menu	<p>Selects a preferred closed captioning mode when the selected input signal carries closed captions.</p> <ul style="list-style-type: none"> <li>• Captions: An on-screen display of the dialogue, narration, and sound effects of TV programs and videos that are closed captioned (usually marked as "CC" in TV listings).</li> </ul> <p> <b>This function is only available when a Composite video or S-Video input signal with NTSC system is selected.</b></p> <p>To view captions, select CC1, CC2, CC3, or CC4 (CC1 displays captions in the primary language in your area).</p>
	<p><b>Lamp Mode</b> See "<a href="#">Setting Lamp Mode as Economic</a>" on page 48 for details.</p> <p><b>Reset Lamp Hours</b> Resets the lamp timer after new lamp is installed. For changing the lamp, please contact qualified service personnel.</p> <p><b>Lamp Hours</b> See "<a href="#">Getting to know the lamp hour</a>" on page 48 for details on how the total lamp hour is calculated.</p>
	<p><b>Filter Settings</b> See "<a href="#">Using the dust filter (optional accessory)</a>" on page 47 for details.</p>
	<p><b>Remote Control Code</b> See "<a href="#">Remote control code</a>" on page 9 for details.</p>
	<p><b>Advanced</b></p> <p><b>Security Settings</b> See "<a href="#">Utilizing the password function</a>" on page 22 for details.</p> <p><b>Panel Key Lock</b> See "<a href="#">Locking control keys</a>" on page 33 for details.</p>
	<p><b>Reset Settings</b></p> <p>Returns all settings to the factory preset values.</p> <p> <b>The following settings will still remain: Keystone, OverScan, Language, Projector Position, High Altitude Mode, Security Settings, Remote Control Code.</b></p>

Function	Description
<b>6. INFORMATION menu</b>  <b>Current System Status</b>	<b>Source</b> Shows the current signal source.  <b>Color Mode</b> Shows the selected mode in the <b>PICTURE</b> menu.  <b>Resolution</b> Shows the native resolution of the input signal.  <b>Color System</b> Shows input system format.  <b>Lamp Hours</b> Displays the number of hours the lamp has been used.  <b>Filter Hours</b> Displays the number of hours the filter has been used.  <b>Firmware Version</b> Shows the current firmware version.

# Maintenance

---

## Care of the projector

You need to keep the lens and/or filter (optional accessory) clean on a regular basis.

Never remove any parts of the projector. Contact your dealer when any part of the projector needs replacing.

### Cleaning the lens

Clean the lens whenever you notice dirt or dust on the surface.

- Use a canister of compressed air to remove dust.
- If there is dirt or smears, use lens-cleaning paper or moisten a soft cloth with lens cleaner and gently wipe the lens surface.

 **CAUTION**

**Never rub the lens with abrasive materials.**

### Cleaning the projector case

Before you clean the case, turn the projector off using the proper shutdown procedure as described in "[Shutting down the projector](#)" on page 36 and unplug the power cord.

- To remove dirt or dust, wipe the case with a soft, lint-free cloth.
- To remove stubborn dirt or stains, moisten a soft cloth with water and a neutral pH detergent. Then wipe the case.

 **CAUTION**

**Never use wax, alcohol, benzene, thinner or other chemical detergents. These can damage the case.**

### Storing the projector

If you need to store the projector for an extended time, please follow the instructions below:

- Make sure the temperature and humidity of the storage area are within the recommended range for the projector. Please refer to "[Specifications](#)" on page 53 or consult your dealer about the range.
- Retract the adjuster foot.
- Remove the battery from the remote control.
- Pack the projector in its original packing or equivalent.

### Transporting the projector

It is recommended that you ship the projector with its original packing or equivalent.

# Using the dust filter (optional accessory)

## ⚠ CAUTION

- It is important to clean the dust filter every 100 hours after the dust filter is installed.
- Be sure to turn off the projector and unplug it from power source before installing or detaching the filter.
- If your projector is ceiling-mounted or is not easily accessible, pay special attention to your personal safety when replacing the dust filter.

## Installing the dust filter

1. Be sure to turn off the projector and unplug it from power source.
2. As the arrows shown to the right, fit the filter by aligning and inserting it into the projector slots. Make sure it clicks into place.

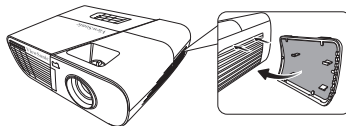

### For first time installation:

3. Open the OSD menu and go to the **SYSTEM SETTING: ADVANCED > Filter Settings** menu.
4. Press **Enter** and the **Filter Settings** page is displayed.
5. Highlight **Filter Mode** and press **◀/▶** to select **On**. The filter timer starts counting and the projector will remind you to clean the filter when the filter is in use for over 100 hours.

⚠ Set **Filter Mode** to **On** only when using the projector after the dust filter (optional accessory) is properly attached. Failing to do so will result in a shorter lamp life.

## Obtaining the filter hour information

1. Open the OSD menu and go to the **SYSTEM SETTING: ADVANCED > Filter Settings** menu.
2. Press **Enter**. The **Filter Settings** page is displayed.
3. You will see the **Filter Hours** information on the menu.

## Cleaning the dust filter

1. Be sure to turn off the projector and unplug it from power source.
2. Press the latches on the dust filter and remove the filter from the projector.
3. Use a small vacuum cleaner or a soft brush to sweep the dust on the filter away.
4. Re-install the dust filter.

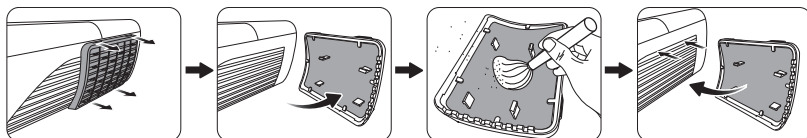

### Resetting the filter timer

5. Open the OSD menu and go to the **SYSTEM SETTING: ADVANCED > Filter Settings** menu.
6. Press **Enter** and the **Filter Settings** page is displayed.
7. Highlight **Reset Filter Hours** and press **Enter**. A warning message is displayed asking if you want to reset the filter timer.

8. Highlight **Reset** and press **Enter**. The lamp time will be reset to '0'.

### CAUTION

Remember to set **Filter Mode** to **Off** in the **SYSTEM SETTING: ADVANCED > Filter Settings** menu when using the projector with the dust filter removed. Setting **Filter Mode** to **Off** does not reset the filter timer. The timer will continue counting the next time you fit the filter back on and set **Filter Mode** to **On**.

## Lamp information

### Getting to know the lamp hour

When the projector is in operation, the duration (in hours) of lamp usage is automatically calculated by the built-in timer.

To obtain the lamp hour information:

1. Open the OSD menu and go to the **SYSTEM SETTING: ADVANCED > Lamp Settings** menu.
2. Press **Enter** and the **Lamp Settings** page is displayed.
3. You will see the **Lamp Hours** information on the menu.
4. To leave the menu, press **Exit**.

You can also get the lamp hour information on the **INFORMATION** menu.

### Extending lamp life

The projection lamp is a consumable item. To keep the lamp life as long as possible, you can do the following settings via the OSD menu.

#### Setting Lamp Mode as Economic

Using **Economic** mode reduces system noise and power consumption by 20%. If the **Economic** mode is selected, the light output will be reduced and result in darker projected pictures.

Setting the projector in **Economic** mode also extends the lamp operation life. To set **Economic** mode, go to the **SYSTEM SETTING: ADVANCED > Lamp Settings > Lamp Mode** menu and press **◀/▶** to select **Economic**.

#### Setting Power Saving

The projector lowers the power consumption if no input source is detected after 5 minutes to prevent unnecessary waste of lamp life. You can further decide if you would like the projector to turn off automatically after a set period of time.

1. Open the OSD menu and go to the **SOURCE > Auto Power Off** menu.
2. Press **Enter** and the **Auto Power Off** page is displayed.
3. Highlight **Power Saving** and press **◀/▶**.
4. When **Disable** is selected, the projector power will be reduced to 30% after no signal is detected for 5 minutes.

If you select **10 min**, **20 min** or **30 min**, the projector power will be reduced to 30% after no signal is detected for 5 minutes. And when **10 min**, **20 min** or **30 min** is up, the projector will turn off automatically.

#### Setting Sleep Timer

This function allows the projector to turn off automatically after a set period of time to prevent unnecessary waste of lamp life.

1. Open the OSD menu and go to the **SOURCE > Auto Power Off** menu.
2. Press **Enter** and the **Auto Power Off** page is displayed.
3. Highlight **Sleep Timer** and press **◀/▶**.
4. If the preset time lengths are not suitable for your presentation, select **Disable**. The projector will not automatically shut down in a certain time period.

## Timing of replacing the lamp

When the **Lamp indicator light** lights up red or a message appears suggesting it is time to replace the lamp, please install a new lamp or consult your dealer. An old lamp may cause a malfunction in the projector and in some instances the lamp may explode.

### CAUTION

The **Lamp indicator light** and **Temperature indicator light** will light up if the lamp becomes too hot. Turn the power off and let the projector cool for 45 minutes. If the **Lamp indicator light** or **Temperature indicator light** still lights up after turning the power back on, please contact your dealer. See "**Indicators**" on page 51 for details.

The following lamp warning displays will remind you to change the lamp.

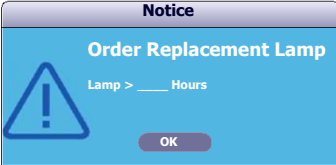
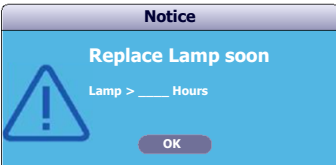
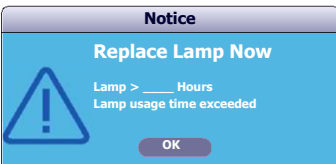
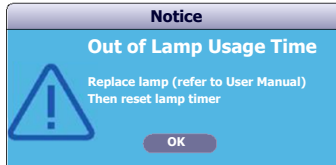
Status	Message
<p>Install a new lamp for optimal performance. If the projector is normally run with <b>Economic</b> selected (See "<b>Setting Lamp Mode as Economic</b>" on page 48), you may continue to operate the projector until the next lamp warning appears.</p>	
<p>A new lamp should be fitted to avoid the inconvenience when the projector runs out of lamp time.</p>	
<p>It is strongly recommended that you replace the lamp at this age. The lamp is a consumable item. The lamp brightness diminishes with use. This is normal lamp behavior. You can replace the lamp whenever you notice that the brightness level has significantly diminished. If the lamp is not replaced beforehand, it must be replaced when you see this message.</p>	
<p>The lamp <b>MUST</b> be replaced before the projector will operate normally.</p>	





## Replacing the lamp

 Turn the power off and disconnect the projector from the power outlet. Please contact qualified service personnel for changing the lamp.

Type number for the replacement lamp:

- PJD5151/PJD5153/PJD5155/PJD5250/PJD5253/PJD5255: RLC-092
- PJD5555w: RLC-093

# Indicators

Light			Status & Description
			
<b>Power events</b>			
<b>Blue Flashing</b>	<b>Off</b>	<b>Off</b>	Stand-by mode
<b>Blue</b>	<b>Off</b>	<b>Off</b>	Powering up
<b>Blue</b>	<b>Off</b>	<b>Off</b>	Normal operation
<b>Blue Flashing</b>	<b>Off</b>	<b>Off</b>	Normal power-down cooling (3 sec)
<b>Red</b>	<b>Off</b>	<b>Off</b>	Downloading
<b>Lamp events</b>			
<b>Blue Flashing</b>	<b>Off</b>	<b>Red</b>	First Lamp-Lit error cooling (60 sec)
<b>Off</b>	<b>Off</b>	<b>Red</b>	Lamp error in normal operation (30 sec)
<b>Blue</b>	<b>Off</b>	<b>Red</b>	CW start fail (30 sec)
<b>Thermal events</b>			
<b>Off</b>	<b>Red</b>	<b>Off</b>	Fan 1 error (the actual fan speed is $\pm 25\%$ outside the desired speed.)
<b>Off</b>	<b>Red</b>	<b>Red</b>	Fan 2 error (the actual fan speed is $\pm 25\%$ outside the desired speed.)
<b>Off</b>	<b>Red</b>	<b>Blue</b>	Fan 3 error (the actual fan speed is $\pm 25\%$ outside the desired speed.)
<b>Off</b>	<b>Red</b>	<b>Purple</b>	Fan 4 error (the actual fan speed is $\pm 25\%$ outside the desired speed.)
<b>Red</b>	<b>Red</b>	<b>Red</b>	Thermal sensor 1 open error (the remote diode has an open-circuit condition.)
<b>Red</b>	<b>Red</b>	<b>Blue</b>	Thermal sensor 2 open error (the remote diode has an open-circuit condition.)
<b>Blue</b>	<b>Red</b>	<b>Red</b>	Thermal sensor 1 short error (the remote diode has an short-circuit condition.)
<b>Off</b>	<b>Red</b>	<b>Blue</b>	Thermal sensor 2 short error (the remote diode has an short-circuit condition.)
<b>Purple</b>	<b>Red</b>	<b>Red</b>	Temperature 1 error (over limited temperature)
<b>Purple</b>	<b>Red</b>	<b>Blue</b>	Temperature 2 error (over limited temperature)
<b>Off</b>	<b>Blue</b>	<b>Red</b>	Fan IC #1 I2C connection error

# Troubleshooting

---

## ① The projector does not turn on.

Cause	Remedy
There is no power from the power cord.	Plug the power cord into the AC inlet on the projector, and plug the power cord into the power outlet. If the power outlet has a switch, make sure that it is switched on.
Attempting to turn the projector on again during the cooling process.	Wait until the cooling down process has completed.

## ① No picture

Cause	Remedy
The video source is not turned on or connected correctly.	Turn the video source on and check that the signal cable is connected correctly.
The projector is not correctly connected to the input signal device.	Check the connection.
The input signal has not been correctly selected.	Select the correct input signal with the <b>Source</b> key on the projector or remote control.

## ① Blurred image

Cause	Remedy
The projection lens is not correctly focused.	Adjust the focus of the lens using the focus ring.
The projector and the screen are not aligned properly.	Adjust the projection angle and direction as well as the height of the projector if necessary.

## ① Remote control does not work

Cause	Remedy
The battery is out of power.	Replace the battery with a new one.
There is an obstacle between the remote control and the projector.	Remove the obstacle.
You are too far away from the projector.	Stand within 8 meters (26 feet) from the projector.

# Specifications

## Projector specifications

-  All specifications are subject to change without notice.
- Not all models can be purchased in your region.

<b>General</b>	
Product name	DLP Projector
<b>Optical</b>	
Resolution	<b>PJD5151/PJD5153/PJD5155:</b> 800 x 600 SVGA <b>PJD5250/PJD5253/PJD5255</b> 1024 x 768 XGA <b>PJD5555w:</b> 1280 x 800 WXGA
Display system	1-CHIP DMD
Lamp	190 W lamp
<b>Electrical</b>	
Power supply	AC100–240V, 50–60 Hz (Automatic)
Power consumption	265 W (Max); < 0.5 W (Standby)
<b>Mechanical</b>	
Weight	<b>PJD5151/PJD5153/PJD5155/PJD5250/PJD5253/PJD5255:</b> 2.1 Kg (4.63 lbs) <b>PJD5555w:</b> 2.0 Kg (4.41 lbs)
<b>Input terminal</b>	
Computer input	
RGB input	D-Sub 15-pin (female) x 2
Video signal input	
S-VIDEO	Mini DIN 4-pin port x 1 ( <b>PJD5153/PJD5155/PJD5253/PJD5255/PJD5555w</b> only)
VIDEO	RCA jack x 1 ( <b>PJD5153/PJD5155/PJD5253/PJD5255/PJD5555w</b> only)
SD/HDTV signal input	
Analog –	D-Sub <-> Component RCA jack x 3 (through RGB input)
Digital –	HDMI V1.4a x 1 ( <b>PJD5155/PJD5255/PJD5555w</b> only)
Audio signal input	Audio jack x 1 ( <b>PJD5153/PJD5155/PJD5253/PJD5255/PJD5555w</b> only)

<b>Output terminal</b>	
RGB output	D-Sub 15-pin (female) x 1 ( <b>PJD5153/PJD5155/PJD5253/PJD5255/PJD5555w</b> only)
Audio signal output	Audio jack x 1 ( <b>PJD5153/PJD5155/PJD5253/PJD5255/PJD5555w</b> only)
Speaker	2 watt x 1 ( <b>PJD5153/PJD5155/PJD5253/PJD5255/PJD5555w</b> only)
<b>Control terminal</b>	
RS-232 serial control	9 pin x 1
LAN	N/A
USB serial control	Type mini B
IR receiver	x 1 (Front)
<b>Environmental Requirements</b>	
Operating temperature	0°C–40°C at sea level
Operating relative humidity	10%–90% (without condensation)
Operating altitude	<ul style="list-style-type: none"> <li>• 0–1499 m at 5°C–35°C</li> <li>• 1500–3000 m at 5°C–25°C (with <b>High Altitude Mode</b> on)</li> </ul>

# Dimensions

315.24 mm (W) x 97.7 mm (H) x 227.93 mm (D) (Excluding extrusions)

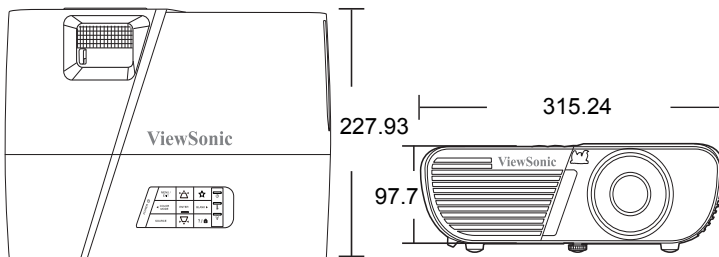

# Ceiling mount installation

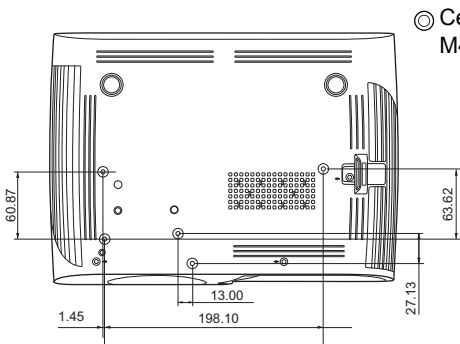

⊙ Ceiling mount screws:  
M4 x 8 (Max. L = 8 mm)

Unit: mm

# Timing chart

<b>Analog RGB</b>			
Signal	Resolution (dots)	Aspect Ratio	Refresh Rate (Hz)
VGA	640 x 480	4:3	60/72/75/85
SVGA	800 x 600	4:3	60/72/75/85
XGA	1024 x 768	4:3	60/70/75/85
	1152 x 864	4:3	75
WXGA	1280 x 768	15:9	60
	1280 x 800	16:10	60/75/85
	1360 x 768	16:9	60
Quad-VGA	1280 x 960	4:3	60/85
SXGA	1280 x 1024	5:4	60
SXGA+	1400 x 1050	4:3	60
WXGA+	1440 x 900	16:10	60
UXGA	1600 x 1200	4:3	60
WSXGA+	1680 x 1050	16:10	60
HD	1280 x 720	16:9	60
MAC 13"	640 x 480	4:3	67
MAC 16"	832 x 624	4:3	75
MAC 19"	1024 x 768	4:3	75
MAC 21"	1152 x 870	4:3	75

<b>HDMI</b>			
Signal	Resolution (dots)	Aspect Ratio	Refresh Rate (Hz)
VGA	640 x 480	4:3	60
SVGA	800 x 600	4:3	60
XGA	1024 x 768	4:3	60
WXGA	1280 x 768	15:9	60
	1280 x 800	16:10	60
	1360 x 768	16:9	60
Quad-VGA	1280 x 960	4:3	60
SXGA	1280 x 1024	5:4	60
SXGA+	1400 x 1050	4:3	60
WXGA+	1440 x 900	16:10	60
WSXGA+	1680 x 1050	16:10	60
HDTV (1080p)	1920 x 1080	16:9	50 / 60
HDTV (1080i)	1920 x 1080	16:9	50 / 60
HDTV (720p)	1280 x 720	16:9	50 / 60
SDTV (480p)	720 x 480	4:3 / 16:9	60
SDTV (576p)	720 x 576	4:3 / 16:9	50
SDTV (480i)	720 x 480	4:3 / 16:9	60
SDTV (576i)	720 x 576	4:3 / 16:9	50



<b>3D (HDMI signal included)</b>			
Signal	Resolution (dots)	Aspect Ratio	Refresh Rate (Hz)
SVGA	800 x 600	4:3	60* / 120**
XGA	1024 x 768	4:3	60* / 120**
HD	1280 x 720	16:9	60* / 120**
WXGA	1280 x 800	16:9	60* / 120**
for Video Signal			
Signal	Resolution (dots)	Aspect Ratio	Refresh Rate (Hz)
SDTV (480i)***	720 x 480	4:3 / 16:9	60
 * 60Hz signals are supported for Side-By-Side, Top-Bottom, and Frame Sequential formats.			
** 120 Hz signals are supported for Frame Sequential format only.			
*** Video signal (SDTV 480i) is supported for Frame Sequential format only.			

<b>HDMI 3D</b>			
In Frame packing format			
Signal	Resolution (dots)	Aspect Ratio	Refresh Rate (Hz)
1080p	1920 x 1080	16:9	23.98/24
720p	1280 x 720	16:9	50/59.94/60
In Side by side format			
Signal	Resolution (dots)	Aspect Ratio	Refresh Rate (Hz)
1080i	1920 x 1080	16:9	50/59.94/60
In Top and Bottom format			
Signal	Resolution (dots)	Aspect Ratio	Refresh Rate (Hz)
1080p	1920 x 1080	16:9	23.98/24
720p	1280 x 720	16:9	50/59.94/60

<b>Component video</b>			
Signal	Resolution (dots)	Aspect Ratio	Refresh Rate (Hz)
HDTV (1080p)	1920 x 1080	16:9	50 / 60
HDTV (1080i)	1920 x 1080	16:9	50 / 60
HDTV (720p)	1280 x 720	16:9	50 / 60
SDTV (480p)	720 x 480	4:3 / 16:9	60
SDTV (576p)	720 x 576	4:3 / 16:9	50
SDTV (480i)	720 x 480	4:3 / 16:9	60
SDTV (576i)	720 x 576	4:3 / 16:9	50

<b>Composite video</b>		
Signal	Aspect Ratio	Refresh Rate (Hz)
NTSC	4:3	60
PAL	4:3	50
PAL60	4:3	60
SECAM	4:3	50

# *Copyright information*

---

## **Copyright**

Copyright 2014. All rights reserved. No part of this publication may be reproduced, transmitted, transcribed, stored in a retrieval system or translated into any language or computer language, in any form or by any means, electronic, mechanical, magnetic, optical, chemical, manual or otherwise, without the prior written permission of ViewSonic Corporation.

## **Disclaimer**

ViewSonic Corporation makes no representations or warranties, either expressed or implied, with respect to the contents hereof and specifically disclaims any warranties, merchantability or fitness for any particular purpose. Further, ViewSonic Corporation reserves the right to revise this publication and to make changes from time to time in the contents hereof without obligation to notify any person of such revision or changes.

\*DLP and Digital Micromirror Device (DMD) are trademarks of Texas Instruments. Others are copyrights of their respective companies or organizations.

# Appendix

---

## IR control table

Key	Format	Byte1	Byte2	Byte3	Byte4
PgDn	NEC	X3	F4	05	FA
PgUp	NEC	X3	F4	06	F9
Blank	NEC	X3	F4	07	F8
Auto sync	NEC	X3	F4	08	F7
Up	NEC	X3	F4	0B	F4
Down	NEC	X3	F4	0C	F3
Left	NEC	X3	F4	0E	F1
Right	NEC	X3	F4	0F	F0
Color Mode	NEC	X3	F4	10	EF
Enter	NEC	X3	F4	15	EA
Power ON	NEC	X3	F4	17	E8
Magnify	NEC	X3	F4	32	CD
Presentation Timer	NEC	X3	F4	27	D8
Exit	NEC	X3	F4	28	D7
D. ECO (Eco mode)	NEC	X3	F4	2B	D4
Menu	NEC	X3	F4	30	CF
Mouse	NEC	X3	F4	31	CE
Mouse Left	NEC	X3	F4	36	C9
Mouse Right	NEC	X3	F4	37	C8
Source	NEC	X3	F4	40	BF
Pattern	NEC	X3	F4	55	AA
My button	NEC	X3	F4	56	A9
HDMI	NEC	X3	F4	58	A7
Volume+	NEC	X3	F4	82	7D
Volume-	NEC	X3	F4	83	7C
Key pad lock	NEC	X3	F4	8E	71
VGA1	NEC	X3	F4	41	be
VGA2	NEC	X3	F4	45	ba
Help	NEC	X3	F4	21	DE
3D	NEC	X3	F4	20	DF

## Address code

Code 1	83F4
Code 2	93F4
Code 3	A3F4
Code 4	B3F4
Code 5	C3F4
Code 6	D3F4
Code 7	E3F4
Code 8	F3F4

## RS232 command table

<Pin assignment for this two end>

Pin	Description	Pin	Description
1	NC	2	RX
3	TX	4	NC
5	GND	6	NC
7	RTSZ	8	CTSZ
9	NC		

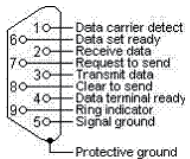

<Interface>

RS-232 protocol	
Baud Rate	115200 bps (default)
Data Length	8 bit
Parity Check	None
Stop Bit	1 bit
Flow Control	None

## <RS232 command table>

Function	Status	Action	cmd
Power	Write	Turn on	0x06 0x14 0x00 0x04 0x00 0x34 0x11 0x00 0x00 0x5D
		Turn off	0x06 0x14 0x00 0x04 0x00 0x34 0x11 0x01 0x00 0x5E
	Read	Power status (on/off)	0x07 0x14 0x00 0x05 0x00 0x34 0x00 0x00 0x11 0x00 0x5E
Reset all settings		Execute	0x06 0x14 0x00 0x04 0x00 0x34 0x11 0x02 0x00 0x5F
Reset Color Settings		Execute	0x06 0x14 0x00 0x04 0x00 0x34 0x11 0x2A 0x00 0x87
Splash Screen	Write	Splash Screen Black	0x06 0x14 0x00 0x04 0x00 0x34 0x11 0x0A 0x00 0x67
		Splash Screen Blue	0x06 0x14 0x00 0x04 0x00 0x34 0x11 0x0A 0x01 0x68
		Splash Screen ViewSonic	0x06 0x14 0x00 0x04 0x00 0x34 0x11 0x0A 0x02 0x69
		Splash Screen Screen Capture	0x06 0x14 0x00 0x04 0x00 0x34 0x11 0x0A 0x03 0x6A
		Splash Screen Off	0x06 0x14 0x00 0x04 0x00 0x34 0x11 0x0A 0x04 0x6B
	Read	Splash Screen status	0x07 0x14 0x00 0x05 0x00 0x34 0x00 0x00 0x11 0x0A 0x68
Quick Power Off	Write	Quick Power Off Off	0x06 0x14 0x00 0x04 0x00 0x34 0x11 0x0B 0x00 0x68
		Quick Power Off On	0x06 0x14 0x00 0x04 0x00 0x34 0x11 0x0B 0x01 0x69
	Read	Quick Power Off status	0x07 0x14 0x00 0x05 0x00 0x34 0x00 0x00 0x11 0x0B 0x69
High Altitude Mode	Write	High Altitude Mode Off	0x06 0x14 0x00 0x04 0x00 0x34 0x11 0x0C 0x00 0x69
		High Altitude Mode On	0x06 0x14 0x00 0x04 0x00 0x34 0x11 0x0C 0x01 0x6A
	Read	High Altitude Mode status	0x07 0x14 0x00 0x05 0x00 0x34 0x00 0x00 0x11 0x0C 0x6A
Lamp Mode	Write	Normal	0x06 0x14 0x00 0x04 0x00 0x34 0x11 0x10 0x00 0x6D
		Economic	0x06 0x14 0x00 0x04 0x00 0x34 0x11 0x10 0x01 0x6E
		Dynamic	0x06 0x14 0x00 0x04 0x00 0x34 0x11 0x10 0x02 0x6F
		Sleep Mode	0x06 0x14 0x00 0x04 0x00 0x34 0x11 0x10 0x03 0x70
	Read	Lamp Mode status	0x07 0x14 0x00 0x05 0x00 0x34 0x00 0x00 0x11 0x10 0x6E

Message	Write	Message Off	0x06 0x14 0x00 0x04 0x00 0x34 0x11 0x27 0x00 0x84
		Message On	0x06 0x14 0x00 0x04 0x00 0x34 0x11 0x27 0x01 0x85
	Read	Message status	0x07 0x14 0x00 0x05 0x00 0x34 0x00 0x00 0x11 0x27 0x85
Projector Position	Write	Front Table	0x06 0x14 0x00 0x04 0x00 0x34 0x12 0x00 0x00 0x5E
		Rear Table	0x06 0x14 0x00 0x04 0x00 0x34 0x12 0x00 0x01 0x5F
		Rear Ceiling	0x06 0x14 0x00 0x04 0x00 0x34 0x12 0x00 0x02 0x60
		Front Ceiling	0x06 0x14 0x00 0x04 0x00 0x34 0x12 0x00 0x03 0x61
	Read	projector position status	0x07 0x14 0x00 0x05 0x00 0x34 0x00 0x00 0x12 0x00 0x5F
3D Sync	Write	OFF	0x06 0x14 0x00 0x04 0x00 0x34 0x12 0x20 0x00 0x7E
		Auto	0x06 0x14 0x00 0x04 0x00 0x34 0x12 0x20 0x01 0x7F
		Frame Sequential	0x06 0x14 0x00 0x04 0x00 0x34 0x12 0x20 0x02 0x80
		Frame Packing	0x06 0x14 0x00 0x04 0x00 0x34 0x12 0x20 0x03 0x81
		Top-Bottom	0x06 0x14 0x00 0x04 0x00 0x34 0x12 0x20 0x04 0x82
		Side-by-Side	0x06 0x14 0x00 0x04 0x00 0x34 0x12 0x20 0x05 0x83
	Read	3D Sync Status	0x07 0x14 0x00 0x05 0x00 0x34 0x00 0x00 0x12 0x20 0x7F
3D Sync Invert	Write	Off	0x06 0x14 0x00 0x04 0x00 0x34 0x12 0x21 0x00 0x7F
		On	0x06 0x14 0x00 0x04 0x00 0x34 0x12 0x21 0x01 0x80
	Read	3D Sync Invert Status	0x07 0x14 0x00 0x05 0x00 0x34 0x00 0x00 0x12 0x21 0x80
Contrast	Write	Contrast decrease	0x06 0x14 0x00 0x04 0x00 0x34 0x12 0x02 0x00 0x60
		Contrast increase	0x06 0x14 0x00 0x04 0x00 0x34 0x12 0x02 0x01 0x61
	Read	Contrast ratio	0x07 0x14 0x00 0x05 0x00 0x34 0x00 0x00 0x12 0x02 0x61
Brightness	Write	Brightness decrease	0x06 0x14 0x00 0x04 0x00 0x34 0x12 0x03 0x00 0x61
		Brightness increase	0x06 0x14 0x00 0x04 0x00 0x34 0x12 0x03 0x01 0x62
	Read	Brightness	0x07 0x14 0x00 0x05 0x00 0x34 0x00 0x00 0x12 0x03 0x62

Aspect ratio	Write	Aspect ratio Auto	0x06 0x14 0x00 0x04 0x00 0x34 0x12 0x04 0x00 0x62
		Aspect ratio 4:3	0x06 0x14 0x00 0x04 0x00 0x34 0x12 0x04 0x02 0x64
		Aspect ratio 16:9	0x06 0x14 0x00 0x04 0x00 0x34 0x12 0x04 0x03 0x65
		Aspect ratio 16:10	0x06 0x14 0x00 0x04 0x00 0x34 0x12 0x04 0x04 0x66
		Aspect ratio Anamorphic	0x06 0x14 0x00 0x04 0x00 0x34 0x12 0x04 0x05 0x67
		Aspect ratio Wide	0x06 0x14 0x00 0x04 0x00 0x34 0x12 0x04 0x06 0x68
		Aspect ratio 2.35:1	0x06 0x14 0x00 0x04 0x00 0x34 0x12 0x04 0x07 0x69
	Aspect ratio Panorama	0x06 0x14 0x00 0x04 0x00 0x34 0x12 0x04 0x08 0x6A	
	Read	Aspect ratio	0x07 0x14 0x00 0x05 0x00 0x34 0x00 0x00 0x12 0x04 0x63
Auto Adjust	Execute		0x06 0x14 0x00 0x04 0x00 0x34 0x12 0x05 0x00 0x63
Horizontal position	Write	Horizontal position shift right	0x06 0x14 0x00 0x04 0x00 0x34 0x12 0x06 0x01 0x65
		Horizontal position shift left	0x06 0x14 0x00 0x04 0x00 0x34 0x12 0x06 0x00 0x64
	Read	Horizontal position	0x07 0x14 0x00 0x05 0x00 0x34 0x00 0x00 0x12 0x06 0x65
Vertical position	Write	Vertical position shift up	0x06 0x14 0x00 0x04 0x00 0x34 0x12 0x07 0x00 0x65
		Vertical position shift down	0x06 0x14 0x00 0x04 0x00 0x34 0x12 0x07 0x01 0x66
	Read	read Vertical position	0x07 0x14 0x00 0x05 0x00 0x34 0x00 0x00 0x12 0x07 0x66



Color temperature	Write	color temperature Warm	0x06 0x14 0x00 0x04 0x00 0x34 0x12 0x08 0x00 0x66
		color temperature Normal	0x06 0x14 0x00 0x04 0x00 0x34 0x12 0x08 0x01 0x67
		color temperature Neutral	0x06 0x14 0x00 0x04 0x00 0x34 0x12 0x08 0x02 0x68
		color temperature Cool	0x06 0x14 0x00 0x04 0x00 0x34 0x12 0x08 0x03 0x69
	Read	color temperature status	0x07 0x14 0x00 0x05 0x00 0x34 0x00 0x00 0x12 0x08 0x67
Blank	Write	Blank on	0x06 0x14 0x00 0x04 0x00 0x34 0x12 0x09 0x01 0x68
		Blank off	0x06 0x14 0x00 0x04 0x00 0x34 0x12 0x09 0x00 0x67
	Read	Blank status	0x07 0x14 0x00 0x05 0x00 0x34 0x00 0x00 0x12 0x09 0x68
Keystone-Vertical	Write	Decrease	0x06 0x14 0x00 0x04 0x00 0x34 0x12 0x0A 0x00 0x68
		Increase	0x06 0x14 0x00 0x04 0x00 0x34 0x12 0x0A 0x01 0x69
	Read	Keystone status	0x07 0x14 0x00 0x05 0x00 0x34 0x00 0x00 0x12 0x0A 0x69
Keystone-Horizontal	Write	Decrease	0x06 0x14 0x00 0x04 0x00 0x34 0x11 0x31 0x00 0x8E
		Increase	0x06 0x14 0x00 0x04 0x00 0x34 0x11 0x31 0x01 0x8F
	Read	Keystone status	0x07 0x14 0x00 0x05 0x00 0x34 0x00 0x00 0x11 0x31 0x8F
Color mode	Write	Brightest	0x06 0x14 0x00 0x04 0x00 0x34 0x12 0x0B 0x00 0x69
		Movie	0x06 0x14 0x00 0x04 0x00 0x34 0x12 0x0B 0x01 0x6A
		Standard	0x06 0x14 0x00 0x04 0x00 0x34 0x12 0x0B 0x04 0x6D
		ViewMatch	0x06 0x14 0x00 0x04 0x00 0x34 0x12 0x0B 0x05 0x6E
		Dynamic	0x06 0x14 0x00 0x04 0x00 0x34 0x12 0x0B 0x08 0x71
	Read	Preset mode status	0x07 0x14 0x00 0x05 0x00 0x34 0x00 0x00 0x12 0x0B 0x6A

Primary Color	Write	Primary color R	0x06 0x14 0x00 0x04 0x00 0x34 0x12 0x10 0x00 0x6E
		Primary color G	0x06 0x14 0x00 0x04 0x00 0x34 0x12 0x10 0x01 0x6F
		Primary color B	0x06 0x14 0x00 0x04 0x00 0x34 0x12 0x10 0x02 0x70
		Primary color C	0x06 0x14 0x00 0x04 0x00 0x34 0x12 0x10 0x03 0x71
		Primary color M	0x06 0x14 0x00 0x04 0x00 0x34 0x12 0x10 0x04 0x72
		Primary color Y	0x06 0x14 0x00 0x04 0x00 0x34 0x12 0x10 0x05 0x73
	Read	Primary color status	0x07 0x14 0x00 0x05 0x00 0x34 0x00 0x00 0x12 0x10 0x6F
Hue	Write	Hue decrease	0x06 0x14 0x00 0x04 0x00 0x34 0x12 0x11 0x00 0x6F
		Hue increase	0x06 0x14 0x00 0x04 0x00 0x34 0x12 0x11 0x01 0x70
	Read	Hue	0x07 0x14 0x00 0x05 0x00 0x34 0x00 0x00 0x12 0x11 0x70
Saturation	Write	Saturation decrease	0x06 0x14 0x00 0x04 0x00 0x34 0x12 0x12 0x00 0x70
		Saturation increase	0x06 0x14 0x00 0x04 0x00 0x34 0x12 0x12 0x01 0x71
	Read	Saturation	0x07 0x14 0x00 0x05 0x00 0x34 0x00 0x00 0x12 0x12 0x71
Gain	Write	Gain decrease	0x06 0x14 0x00 0x04 0x00 0x34 0x12 0x13 0x00 0x71
		Gain increase	0x06 0x14 0x00 0x04 0x00 0x34 0x12 0x13 0x01 0x72
	Read	Gain	0x07 0x14 0x00 0x05 0x00 0x34 0x00 0x00 0x12 0x13 0x72
Freeze	Write	Freeze on	0x06 0x14 0x00 0x04 0x00 0x34 0x13 0x00 0x01 0x60
		Freeze off	0x06 0x14 0x00 0x04 0x00 0x34 0x13 0x00 0x00 0x5F
	Read	Freeze status	0x07 0x14 0x00 0x05 0x00 0x34 0x00 0x00 0x13 0x00 0x60

Source input	Write	Input source VGA	0x06 0x14 0x00 0x04 0x00 0x34 0x13 0x01 0x00 0x60
		Input source VGA2	0x06 0x14 0x00 0x04 0x00 0x34 0x13 0x01 0x08 0x68
		Input source HDMI	0x06 0x14 0x00 0x04 0x00 0x34 0x13 0x01 0x03 0x63
		Input source Composite	0x06 0x14 0x00 0x04 0x00 0x34 0x13 0x01 0x05 0x65
		Input source SVIDEO	0x06 0x14 0x00 0x04 0x00 0x34 0x13 0x01 0x06 0x66
Read	Source	0x07 0x14 0x00 0x05 0x00 0x34 0x00 0x00 0x13 0x01 0x61	
Quick Auto Search	Write	Quick Auto Search on	0x06 0x14 0x00 0x04 0x00 0x34 0x13 0x02 0x01 0x62
		Quick Auto Search off	0x06 0x14 0x00 0x04 0x00 0x34 0x13 0x02 0x00 0x61
	Read	Quick Auto Search status	0x07 0x14 0x00 0x05 0x00 0x34 0x00 0x00 0x13 0x02 0x62
Mute	Write	Mute on	0x06 0x14 0x00 0x04 0x00 0x34 0x14 0x00 0x01 0x61
		Mute off	0x06 0x14 0x00 0x04 0x00 0x34 0x14 0x00 0x00 0x60
	Read	Mute status	0x07 0x14 0x00 0x05 0x00 0x34 0x00 0x00 0x14 0x00 0x61
Volume	Write	Increase Volume	0x06 0x14 0x00 0x04 0x00 0x34 0x14 0x01 0x00 0x61
		Decrease Volume	0x06 0x14 0x00 0x04 0x00 0x34 0x14 0x02 0x00 0x62
	Read	Volume	0x07 0x14 0x00 0x05 0x00 0x34 0x00 0x00 0x14 0x03 0x64

Language	Write	ENGLISH	0x06 0x14 0x00 0x04 0x00 0x34 0x15 0x00 0x00 0x61
		FRANÇAIS	0x06 0x14 0x00 0x04 0x00 0x34 0x15 0x00 0x01 0x62
		DEUTSCH	0x06 0x14 0x00 0x04 0x00 0x34 0x15 0x00 0x02 0x63
		ITALIANO	0x06 0x14 0x00 0x04 0x00 0x34 0x15 0x00 0x03 0x64
		ESPAÑOL	0x06 0x14 0x00 0x04 0x00 0x34 0x15 0x00 0x04 0x65
		РУССКИЙ	0x06 0x14 0x00 0x04 0x00 0x34 0x15 0x00 0x05 0x66
		繁體中文	0x06 0x14 0x00 0x04 0x00 0x34 0x15 0x00 0x06 0x67
		簡體中文	0x06 0x14 0x00 0x04 0x00 0x34 0x15 0x00 0x07 0x68
		日本語	0x06 0x14 0x00 0x04 0x00 0x34 0x15 0x00 0x08 0x69
		한국어	0x06 0x14 0x00 0x04 0x00 0x34 0x15 0x00 0x09 0x6A
		Svenska	0x06 0x14 0x00 0x04 0x00 0x34 0x15 0x00 0x0a 0x6B
		Nederlands	0x06 0x14 0x00 0x04 0x00 0x34 0x15 0x00 0x0b 0x6C
		Türkçe	0x06 0x14 0x00 0x04 0x00 0x34 0x15 0x00 0x0c 0x6D
		Čeština	0x06 0x14 0x00 0x04 0x00 0x34 0x15 0x00 0x0d 0x6E
		Português	0x06 0x14 0x00 0x04 0x00 0x34 0x15 0x00 0x0e 0x6F
		இலங்கை	0x06 0x14 0x00 0x04 0x00 0x34 0x15 0x00 0x0f 0x70
		Polski	0x06 0x14 0x00 0x04 0x00 0x34 0x15 0x00 0x10 0x71
		Suomi	0x06 0x14 0x00 0x04 0x00 0x34 0x15 0x00 0x11 0x72
		العربية	0x06 0x14 0x00 0x04 0x00 0x34 0x15 0x00 0x12 0x73
	Indonesian	0x06 0x14 0x00 0x04 0x00 0x34 0x15 0x00 0x13 0x74	
हिन्दी	0x06 0x14 0x00 0x04 0x00 0x34 0x15 0x00 0x14 0x75		
Lamp Time	Read	Language	0x07 0x14 0x00 0x05 0x00 0x34 0x00 0x00 0x15 0x00 0x62
	Write	Reset Lamp usage hour	0x06 0x14 0x00 0x04 0x00 0x34 0x15 0x01 0x00 0x62
Lamp Time	Read	Lamp usage hour	0x07 0x14 0x00 0x05 0x00 0x34 0x00 0x00 0x15 0x01 0x63

HDMI Format	Write	RGB	0x06 0x14 0x00 0x04 0x00 0x34 0x11 0x28 0x00 0x85
		YUV	0x06 0x14 0x00 0x04 0x00 0x34 0x11 0x28 0x01 0x86
		Auto	0x06 0x14 0x00 0x04 0x00 0x34 0x11 0x28 0x02 0x87
	Read	HDMI Format status	0x07 0x14 0x00 0x05 0x00 0x34 0x00 0x00 0x11 0x28 0x86
HDMI Range	Write	Enhanced	0x06 0x14 0x00 0x04 0x00 0x34 0x11 0x29 0x00 0x86
		Normal	0x06 0x14 0x00 0x04 0x00 0x34 0x11 0x29 0x01 0x87
		Auto	0x06 0x14 0x00 0x04 0x00 0x34 0x11 0x29 0x02 0x88
	Read	HDMI Range status	0x07 0x14 0x00 0x05 0x00 0x34 0x00 0x00 0x11 0x29 0x87
CEC	Write	Off	0x06 0x14 0x00 0x04 0x00 0x34 0x11 0x2B 0x00 0x88
		On	0x06 0x14 0x00 0x04 0x00 0x34 0x11 0x2B 0x01 0x89
	Read	CEC status	0x07 0x14 0x00 0x05 0x00 0x34 0x00 0x00 0x11 0x2B 0x89
Error status	Read	Read error status	0x07 0x14 0x00 0x05 0x00 0x34 0x00 0x00 0x0C 0x0D 0x66
Brilliant Color	Write	Brilliant Color <sub>0</sub>	0x06 0x14 0x00 0x04 0x00 0x34 0x12 0x0F 0x00 0x6D
		Brilliant Color <sub>1</sub>	0x06 0x14 0x00 0x04 0x00 0x34 0x12 0x0F 0x01 0x6E
		Brilliant Color <sub>2</sub>	0x06 0x14 0x00 0x04 0x00 0x34 0x12 0x0F 0x02 0x6F
		Brilliant Color <sub>3</sub>	0x06 0x14 0x00 0x04 0x00 0x34 0x12 0x0F 0x03 0x70
		Brilliant Color <sub>4</sub>	0x06 0x14 0x00 0x04 0x00 0x34 0x12 0x0F 0x04 0x71
		Brilliant Color <sub>5</sub>	0x06 0x14 0x00 0x04 0x00 0x34 0x12 0x0F 0x05 0x72
		Brilliant Color <sub>6</sub>	0x06 0x14 0x00 0x04 0x00 0x34 0x12 0x0F 0x06 0x73
		Brilliant Color <sub>7</sub>	0x06 0x14 0x00 0x04 0x00 0x34 0x12 0x0F 0x07 0x74
		Brilliant Color <sub>8</sub>	0x06 0x14 0x00 0x04 0x00 0x34 0x12 0x0F 0x08 0x75
		Brilliant Color <sub>9</sub>	0x06 0x14 0x00 0x04 0x00 0x34 0x12 0x0F 0x09 0x76
	Brilliant Color <sub>10</sub>	0x06 0x14 0x00 0x04 0x00 0x34 0x12 0x0F 0x0A 0x77	
Read	Brilliant Color status	0x07 0x14 0x00 0x05 0x00 0x34 0x00 0x00 0x12 0x0F 0x6E	

Remote Control code	Write	code 1	0x06 0x14 0x00 0x04 0x00 0x34 0x0C 0x48 0x00 0xA0
		code 2	0x06 0x14 0x00 0x04 0x00 0x34 0x0C 0x48 0x01 0xA1
		code 3	0x06 0x14 0x00 0x04 0x00 0x34 0x0C 0x48 0x02 0xA2
		code 4	0x06 0x14 0x00 0x04 0x00 0x34 0x0C 0x48 0x03 0xA3
		code 5	0x06 0x14 0x00 0x04 0x00 0x34 0x0C 0x48 0x04 0xA4
		code 6	0x06 0x14 0x00 0x04 0x00 0x34 0x0C 0x48 0x05 0xA5
		code 7	0x06 0x14 0x00 0x04 0x00 0x34 0x0C 0x48 0x06 0xA6
		code 8	0x06 0x14 0x00 0x04 0x00 0x34 0x0C 0x48 0x07 0xA7
	Read	Remote Control code status	0x07 0x14 0x00 0x05 0x00 0x34 0x00 0x00 0x0C 0x048 0xA1
Screen Color	Write	Screen color Off	0x06 0x14 0x00 0x04 0x00 0x34 0x11 0x32 0x00 0x8F
		Blackboard	0x06 0x14 0x00 0x04 0x00 0x34 0x11 0x32 0x01 0x90
		Greenboard	0x06 0x14 0x00 0x04 0x00 0x34 0x11 0x32 0x02 0x91
		Whiteboard	0x06 0x14 0x00 0x04 0x00 0x34 0x11 0x32 0x03 0x92
	Read	Screen Color status	0x07 0x14 0x00 0x05 0x00 0x34 0x00 0x00 0x11 0x32 0x90
Over Scan	Write	Overscan Off	0x06 0x14 0x00 0x04 0x00 0x34 0x11 0x33 0x00 0x90
		Overscan 1	0x06 0x14 0x00 0x04 0x00 0x34 0x11 0x33 0x01 0x91
		Overscan 2	0x06 0x14 0x00 0x04 0x00 0x34 0x11 0x33 0x02 0x92
		Overscan 3	0x06 0x14 0x00 0x04 0x00 0x34 0x11 0x33 0x03 0x93
		Overscan 4	0x06 0x14 0x00 0x04 0x00 0x34 0x11 0x33 0x04 0x94
		Overscan 5	0x06 0x14 0x00 0x04 0x00 0x34 0x11 0x33 0x05 0x95
	Read	Overscan status	0x07 0x14 0x00 0x05 0x00 0x34 0x00 0x00 0x11 0x33 0x91

Remote Key	Write	Menu	0x02 0x14 0x00 0x04 0x00 0x34 0x02 0x04 0x0F 0x61
		Exit	0x02 0x14 0x00 0x04 0x00 0x34 0x02 0x04 0x13 0x65
		Up	0x02 0x14 0x00 0x04 0x00 0x34 0x02 0x04 0x0B 0x5D
		Down	0x02 0x14 0x00 0x04 0x00 0x34 0x02 0x04 0x0C 0x5E
		Left	0x02 0x14 0x00 0x04 0x00 0x34 0x02 0x04 0x0D 0x5F
		Right	0x02 0x14 0x00 0x04 0x00 0x34 0x02 0x04 0x0E 0x60
		Source	0x02 0x14 0x00 0x04 0x00 0x34 0x02 0x04 0x04 0x56
		Enter	0x02 0x14 0x00 0x04 0x00 0x34 0x02 0x04 0x15 0x67
		Auto	0x02 0x14 0x00 0x04 0x00 0x34 0x02 0x04 0x08 0x5A
		My Button	0x02 0x14 0x00 0x04 0x00 0x34 0x02 0x04 0x11 0x63

# Customer Support

For technical support or product service, see the table below or contact your reseller.

**NOTE:** You will need the product serial number.

Country/Region	Website	T= Telephone C = CHAT ONLINE	Email
Australia New Zealand	www.viewsonic.com.au	AUS= 1800 880 818 NZ= 0800 008 822	service@au.viewsonic.com
Canada	www.viewsonic.com	T (Toll-Free)= 1-866-463-4775 T (Toll)= 1-424-233-2533	service.ca@viewsonic.com
Europe	www.viewsoniceurope.com	www.viewsoniceurope.com/uk/support/call-desk/	
Hong Kong	www.hk.viewsonic.com	T= 852 3102 2900	service@hk.viewsonic.com
India	www.in.viewsonic.com	T= 1800 266 0101	service@in.viewsonic.com
Korea	ap.viewsonic.com/kr/	T= 080 333 2131	service@kr.viewsonic.com
Latin America (Argentina)	www.viewsonic.com/la/	C= <a href="http://www.viewsonic.com/la/soporte/servicio-tecnico">http://www.viewsonic.com/la/soporte/servicio-tecnico</a>	soporte@viewsonic.com
Latin America (Chile)	www.viewsonic.com/la/	C= <a href="http://www.viewsonic.com/la/soporte/servicio-tecnico">http://www.viewsonic.com/la/soporte/servicio-tecnico</a>	soporte@viewsonic.com
Latin America (Columbia)	www.viewsonic.com/la/	C= <a href="http://www.viewsonic.com/la/soporte/servicio-tecnico">http://www.viewsonic.com/la/soporte/servicio-tecnico</a>	soporte@viewsonic.com
Latin America (Mexico)	www.viewsonic.com/la/	C= <a href="http://www.viewsonic.com/la/soporte/servicio-tecnico">http://www.viewsonic.com/la/soporte/servicio-tecnico</a>	soporte@viewsonic.com
Nexus Hightech Solutions, Cincinnati #40 Desp. 1 Col. De los Deportes Mexico D.F. Tel: 55) 6547-6454 55)6547-6484 Other places please refer to <a href="http://www.viewsonic.com/la/soporte/servicio-tecnico#mexico">http://www.viewsonic.com/la/soporte/servicio-tecnico#mexico</a>			
Latin America (Peru)	www.viewsonic.com/la/	C= <a href="http://www.viewsonic.com/la/soporte/servicio-tecnico">http://www.viewsonic.com/la/soporte/servicio-tecnico</a>	soporte@viewsonic.com
Macau	www.hk.viewsonic.com	T= 853 2870 0303	service@hk.viewsonic.com
Middle East	ap.viewsonic.com/me/	Contact your reseller	service@ap.viewsonic.com
Puerto Rico & Virgin Islands	www.viewsonic.com	T= 1-800-688-6688 (English) C= <a href="http://www.viewsonic.com/la/soporte/servicio-tecnico">http://www.viewsonic.com/la/soporte/servicio-tecnico</a>	service.us@viewsonic.com soporte@viewsonic.com
Singapore/ Malaysia/Thailand	www.ap.viewsonic.com	T= 65 6461 6044	service@sg.viewsonic.com
South Africa	ap.viewsonic.com/za/	Contact your reseller	service@ap.viewsonic.com
United States	www.viewsonic.com	T (Toll-Free)= 1-800-688-6688 T (Toll)= 1-424-233-2530	service.us@viewsonic.com



# Limited Warranty

## ViewSonic® Projector

### What the warranty covers:

ViewSonic warrants its products to be free from defects in material and workmanship, under normal use, during the warranty period. If a product proves to be defective in material or workmanship during the warranty period, ViewSonic will, at its sole option, repair or replace the product with a like product. Replacement product or parts may include remanufactured or refurbished parts or components.

### Limited Three (3) year General Warranty

Subject to the more limited one (1) year warranty set out below, North and South America: Three (3) years warranty for all parts excluding the lamp, three (3) years for labor, and one (1) year for the original lamp from the date of the first consumer purchase.

Other regions or countries: Please check with your local dealer or local ViewSonic office for the warranty information.

### Limited One (1) year Heavy Usage Warranty:

Under heavy usage settings, where a projector's use includes more than fourteen (14) hours average daily usage, North and South America: One (1) year warranty for all parts excluding the lamp, one (1) year for labor, and ninety (90) days for the original lamp from the date of the first consumer purchase; Europe: One (1) year warranty for all parts excluding the lamp, one (1) year for labor, and ninety (90) days for the original lamp from the date of the first consumer purchase.

Other regions or countries: Please check with your local dealer or local ViewSonic office for the warranty information.

Lamp warranty subject to terms and conditions, verification and approval. Applies to manufacturer's installed lamp only. All accessory lamps purchased separately are warranted for 90 days.

### Who the warranty protects:

This warranty is valid only for the first consumer purchaser.

### What the warranty does not cover:

1. Any product on which the serial number has been defaced, modified or removed.
2. Damage, deterioration or malfunction resulting from:
  - a. Accident, abuse, misuse, neglect, fire, water, lightning, or other acts of nature, improper maintenance, unauthorized product modification, or failure to follow instructions supplied with the product.
  - b. Operation outside of product specifications.
  - c. Operation of the product for other than the normal intended use or not under normal conditions.
  - d. Repair or attempted repair by anyone not authorized by ViewSonic.
  - e. Any damage of the product due to shipment.
  - f. Removal or installation of the product.
  - g. Causes external to the product, such as electric power fluctuations or failure.
  - h. Use of supplies or parts not meeting ViewSonic's specifications.
  - i. Normal wear and tear.
  - j. Any other cause which does not relate to a product defect.
3. Removal, installation, one way transportation, insurance, and set-up service charges.

**How to get service:**

1. For information about receiving service under warranty, contact ViewSonic Customer Support (Please refer to Customer Support page). You will need to provide your product's serial number.
2. To obtain warranty service, you will be required to provide (a) the original dated sales slip, (b) your name, (c) your address, (d) a description of the problem, and (e) the serial number of the product.
3. Take or ship the product freight prepaid in the original container to an authorized ViewSonic service center or ViewSonic.
4. For additional information or the name of the nearest ViewSonic service center, contact ViewSonic.

**Limitation of implied warranties:**

There are no warranties, express or implied, which extend beyond the description contained herein including the implied warranty of merchantability and fitness for a particular purpose.

**Exclusion of damages:**

ViewSonic's liability is limited to the cost of repair or replacement of the product. ViewSonic shall not be liable for:

1. Damage to other property caused by any defects in the product, damages based upon inconvenience, loss of use of the product, loss of time, loss of profits, loss of business opportunity, loss of goodwill, interference with business relationships, or other commercial loss, even if advised of the possibility of such damages.
2. Any other damages, whether incidental, consequential or otherwise.
3. Any claim against the customer by any other party.
4. Repair or attempted repair by anyone not authorized by ViewSonic.

**Effect of state law:**

This warranty gives you specific legal rights, and you may also have other rights which vary from state to state. Some states do not allow limitations on implied warranties and/or do not allow the exclusion of incidental or consequential damages, so the above limitations and exclusions may not apply to you.

**Sales outside the U.S.A. and Canada:**

For warranty information and service on ViewSonic products sold outside of the U.S.A. and Canada, contact ViewSonic or your local ViewSonic dealer.

The warranty period for this product in mainland China (Hong Kong, Macao and Taiwan Excluded) is subject to the terms and conditions of the Maintenance Guarantee Card.

For users in Europe and Russia, full details of warranty provided can be found in [www.viewsoniceurope.com](http://www.viewsoniceurope.com) under Support/Warranty Information.

# Mexico Limited Warranty

## ViewSonic® Projector

### What the warranty covers:

ViewSonic warrants its products to be free from defects in material and workmanship, under normal use, during the warranty period. If a product proves to be defective in material or workmanship during the warranty period, ViewSonic will, at its sole option, repair or replace the product with a like product. Replacement product or parts may include remanufactured or refurbished parts or components & accessories.

### How long the warranty is effective:

3 years for all parts excluding the lamp, 3 years for labor, 1 year for the original lamp from the date of the first consumer purchase.

Lamp warranty subject to terms and conditions, verification and approval. Applies to manufacturer's installed lamp only.

All accessory lamps purchased separately are warranted for 90 days.

### Who the warranty protects:

This warranty is valid only for the first consumer purchaser.

### What the warranty does not cover:

1. Any product on which the serial number has been defaced, modified or removed.
2. Damage, deterioration or malfunction resulting from:
  - a. Accident, misuse, neglect, fire, water, lightning, or other acts of nature, unauthorized product modification, unauthorized attempted repair, or failure to follow instructions supplied with the product.
  - b. Any damage of the product due to shipment.
  - c. Causes external to the product, such as electrical power fluctuations or failure.
  - d. Use of supplies or parts not meeting ViewSonic's specifications.
  - e. Normal wear and tear.
  - f. Any other cause which does not relate to a product defect.
3. Any product exhibiting a condition commonly known as "image burn-in" which results when a static image is displayed on the product for an extended period of time.
4. Removal, installation, insurance, and set-up service charges.

### How to get service:

For information about receiving service under warranty, contact ViewSonic Customer Support (Please refer to the attached Customer Support page). You will need to provide your product's serial number, so please record the product information in the space provided below on your purchase for your future use. Please retain your receipt of proof of purchase to support your warranty claim.

For Your Records

Product Name: \_\_\_\_\_ Model Number: \_\_\_\_\_  
Document Number: \_\_\_\_\_ Serial Number: \_\_\_\_\_  
Purchase Date: \_\_\_\_\_ Extended Warranty Purchase? \_\_\_\_\_ (Y/N)  
If so, what date does warranty expire? \_\_\_\_\_

1. To obtain warranty service, you will be required to provide (a) the original dated sales slip, (b) your name, (c) your address, (d) a description of the problem, and (e) the serial number of the product.
2. Take or ship the product in the original container packaging to an authorized ViewSonic service center.
3. Round trip transportation costs for in-warranty products will be paid by ViewSonic.

### Limitation of implied warranties:

There are no warranties, express or implied, which extend beyond the description contained herein including the implied warranty of merchantability and fitness for a particular purpose.

### Exclusion of damages:

ViewSonic's liability is limited to the cost of repair or replacement of the product. ViewSonic shall not be liable for:

1. Damage to other property caused by any defects in the product, damages based upon inconvenience, loss of use of the product, loss of time, loss of profits, loss of business opportunity, loss of goodwill, interference with business relationships, or other commercial loss, even if advised of the possibility of such damages.
2. Any other damages, whether incidental, consequential or otherwise.
3. Any claim against the customer by any other party.
4. Repair or attempted repair by anyone not authorized by ViewSonic.

<b>Contact Information for Sales &amp; Authorized Service (Centro Autorizado de Servicio) within Mexico:</b>	
<b>Name, address, of manufacturer and importers:</b> México, Av. de la Palma #8 Piso 2 Despacho 203, Corporativo Interpalmas, Col. San Fernando Huixquilucan, Estado de México Tel: (55) 3605-1099 <a href="http://www.viewsonic.com/la/soporte/index.htm">http://www.viewsonic.com/la/soporte/index.htm</a>	
<b>NÚMERO GRATIS DE ASISTENCIA TÉCNICA PARA TODO MÉXICO: 001.866.823.2004</b>	
<b>Hermosillo:</b> Distribuciones y Servicios Computacionales SA de CV. Calle Juarez 284 local 2 Col. Bugambillas C.P: 83140 Tel: 01-66-22-14-9005 E-Mail: <a href="mailto:disc2@hmo.megared.net.mx">disc2@hmo.megared.net.mx</a>	<b>Villahermosa:</b> Compumantenimientos Garantizados, S.A. de C.V. AV. GREGORIO MENDEZ #1504 COL, FLORIDA C.P. 86040 Tel: 01 (993) 3 52 00 47 / 3522074 / 3 52 20 09 E-Mail: <a href="mailto:compumantenimientos@prodigy.net.mx">compumantenimientos@prodigy.net.mx</a>
<b>Puebla, Pue. (Matriz):</b> RENTA Y DATOS, S.A. DE C.V. Domicilio: 29 SUR 721 COL. LA PAZ 72160 PUEBLA, PUE. Tel: 01(52).222.891.55.77 CON 10 LINEAS E-Mail: <a href="mailto:datos@puebla.megared.net.mx">datos@puebla.megared.net.mx</a>	<b>Veracruz, Ver.:</b> CONEXION Y DESARROLLO, S.A DE C.V. Av. Americas # 419 ENTRE PINZÓN Y ALVARADO Fracc. Reforma C.P. 91919 Tel: 01-22-91-00-31-67 E-Mail: <a href="mailto:gacosta@qplus.com.mx">gacosta@qplus.com.mx</a>
<b>Chihuahua</b> Soluciones Globales en Computación C. Magisterio # 3321 Col. Magisterial Chihuahua, Chih. Tel: 4136954 E-Mail: <a href="mailto:Cefeo@soluglobales.com">Cefeo@soluglobales.com</a>	<b>Cuernavaca</b> Compusupport de Cuernavaca SA de CV Francisco Leyva # 178 Col. Miguel Hidalgo C.P. 62040, Cuernavaca Morelos Tel: 01 777 3180579 / 01 777 3124014 E-Mail: <a href="mailto:aquevedo@compusupportcva.com">aquevedo@compusupportcva.com</a>
<b>Distrito Federal:</b> QPLUS, S.A. de C.V. Av. Coyoacán 931 Col. Del Valle 03100, México, D.F. Tel: 01(52)55-50-00-27-35 E-Mail : <a href="mailto:gacosta@qplus.com.mx">gacosta@qplus.com.mx</a>	<b>Guadalajara, Jal.:</b> SERVICRECE, S.A. de C.V. Av. Niños Héroes # 2281 Col. Arcos Sur, Sector Juárez 44170, Guadalajara, Jalisco Tel: 01(52)33-36-15-15-43 E-Mail: <a href="mailto:mmiranda@servicrece.com">mmiranda@servicrece.com</a>
<b>Guerrero Acapulco</b> GS Computación (Grupo Sesicomp) Progreso #6-A, Colo Centro 39300 Acapulco, Guerrero Tel: 744-48-32627	<b>Monterrey:</b> Global Product Services Mar Caribe # 1987, Esquina con Golfo Pérsico Fracc. Bernardo Reyes, CP 64280 Monterrey N.L. México Tel: 8129-5103 E-Mail: <a href="mailto:aydeem@gps1.com.mx">aydeem@gps1.com.mx</a>
<b>MERIDA:</b> ELECTROSER Av Reforma No. 403Gx39 y 41 Mérida, Yucatán, México CP97000 Tel: (52) 999-925-1916 E-Mail: <a href="mailto:rrrb@sureste.com">rrrb@sureste.com</a>	<b>Oaxaca, Oax.:</b> CENTRO DE DISTRIBUCION Y SERVICIO, S.A. de C.V. Murguía # 708 P.A., Col. Centro, 68000, Oaxaca Tel: 01(52)95-15-15-22-22 Fax: 01(52)95-15-13-67-00 E-Mail: <a href="mailto:gpotai2001@hotmail.com">gpotai2001@hotmail.com</a>
<b>Tijuana:</b> STD Av Ferrocarril Sonora #3780 L-C Col 20 de Noviembre Tijuana, Mexico	<b>FOR USA SUPPORT:</b> ViewSonic Corporation 14035 Pipeline Ave. Chino, CA 91710, USA Tel: 800-688-6688 (English); 866-323-8056 (Spanish); E-Mail: <a href="http://www.viewsonic.com">http://www.viewsonic.com</a>



**ViewSonic®**

S/N: U4T170601412

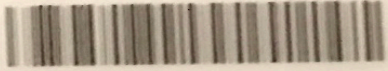

Serial No: U4T170601412

Donated to SGCASG Feb 2019 by Sandi Dickenson

# ViewSonic PJD5555W

DLP PROJECTOR/DLP PROJECTEUR/

DLP 投影机

MODEL/MOÈLE/產品型號: VS15876

INPUT/ENTRÉE/輸入/TEGANGAN:

100-240V ~ 50-60Hz 3.0A (3.0A)

Made in China

Fabricado en China

Buatan China / 製造地: 中國

S/N: U4T170601412 S



MANUFACTURING DATE/

제조년월/製造日期: February, 2017/ 2017年02月

Consumo de energia: 237,46 Wh

Consumo de energia en modo de espera: 0,18 Wh



ViewSonic Corporation  
10 Pointe Drive, Suite 200, Brea, CA 92821, U.S.A.  
ViewSonic Europe Limited/UK  
1st Floor, Salamanca Place, 9 Albert Embankment,  
London SE1 7SP, United Kingdom

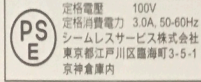

KTR YU10025-14001  
MSIP-REM-VIE-VS15871



제품명: 프로젝터 (Projector)

모델명: VS15876

정격전압: 100-240V~, 50-60Hz,

제조년월: 3.0A

신청인: ViewSonic Corporation

제조회사명: 퀴스다 옵트로닉스

(수조우)(주)

제조국: China / 중국

A/S 센터: 080-333-2131

IS 13252 (Part 1)  
IEC 60950-1



R-41007005

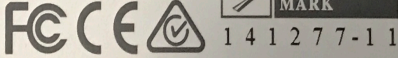

This device complies with part 15 of the FCC Rules. Operation is subject to the following two conditions:  
(1) this device may not cause harmful interference, and  
(2) this device must accept any interference received, including interference that may cause undesired operation.



This Class B digital apparatus complies with Canadian ICES-003.  
Cet appareil numérique de la classe B est conforme à la norme NMB-003 du Canada.

CAN ICES-3 (B)/NMB-3(B)

LT



Lamp Unit: RLC-093  
P/N: 9J.2J277.V2A  
REV.: 01-104

### HIGH VOLTAGE / HIGH TEMPERATURE / HIGH PRESSURE

BEFORE REPLACING THE LAMP, TURN OFF THE PROJECTOR AND REMOVE THE CABLE FROM THE WALL SOCKET. WAIT UNTIL THE LAMP HAS COOLED DOWN (MINIMUM OF 45 MINUTES). TOUCHING THE LAMP WHEN IT IS HOT MAY CAUSE BURNING. THIS IS A HIGH-PRESSURE LAMP WHICH WHEN HOT, MAY EXPLODE IF IT IS IMPROPERLY HANDLED. PLEASE REFER TO THE USER'S GUIDE FOR MORE INFORMATION.

### HAUTE TENSION / HAUTE TEMPÉRATURE / HAUTE PRESSION

AVANT DE REMPLACER LA LAMPE, ÉTEIGNEZ LE PROJECTEUR ET RETIREZ LE CÂBLE DE LA PRISE MURALE. ATTENDEZ QUE LA LAMPE AIT REFROIDI (AU MINIMUM 45 MINUTES). TOUCHER LA LAMPE LORSQU'ELLE EST CHAUDE PEUT PROVOQUER UNE BRÛLURE. CECI EST UNE LAMPE HAUTE PRESSION QUI LORSQU'ELLE EST CHAUDE, PEUT EXPLOSER SI ELLE EST MANIPULÉE INCORRECTEMENT. VEUILLEZ CONSULTER LE GUIDE DE L'UTILISATEUR POUR PLUS D'INFORMATIONS.



WARNING  
RISK OF ELECTRICAL SHOCK - DO NOT OPEN.  
REFER SERVICING TO QUALIFIED SERVICE PERSONNEL.

AVERTISSEMENT  
RISQUE D'ÉLECTROCUTION - NE PAS OUVRIR.  
CONSULTEZ UN TECHNICIEN DE SERVICE QUALIFIÉ POUR TOUTE RÉPARATION.

Lamp(s) Contain Mercury,  
Dispose Properly.



La lampe contient du mercure,  
Disposer correctement.



19:54 Mon Feb 17



53%



## Order Details

Ordered on August 11, 2017 | Order# 113-5012960-4264269

### Shipping Address

Sandra M Dickenson  
8450 WEBBER RD  
SARASOTA, FL 34240-9520  
United States

### Payment Method

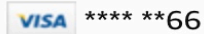

### Order Summary

Item(s) Subtotal:	\$340.99
Shipping & Handling:	\$0.00
Total before tax:	\$340.99
Estimated tax to be collected:	\$23.87
<b>Grand Total:</b>	<b>\$364.86</b>

### Transactions

### ViewSonic PJD5555W 3300 Lumens WXGA HDMI Projector (Certified Refurbished)

Sold by: ViewSonic Corporation

\$340.99

Condition: New

